

# WSDA<sup>®</sup>-2000

Wireless Sensor Data Aggregator

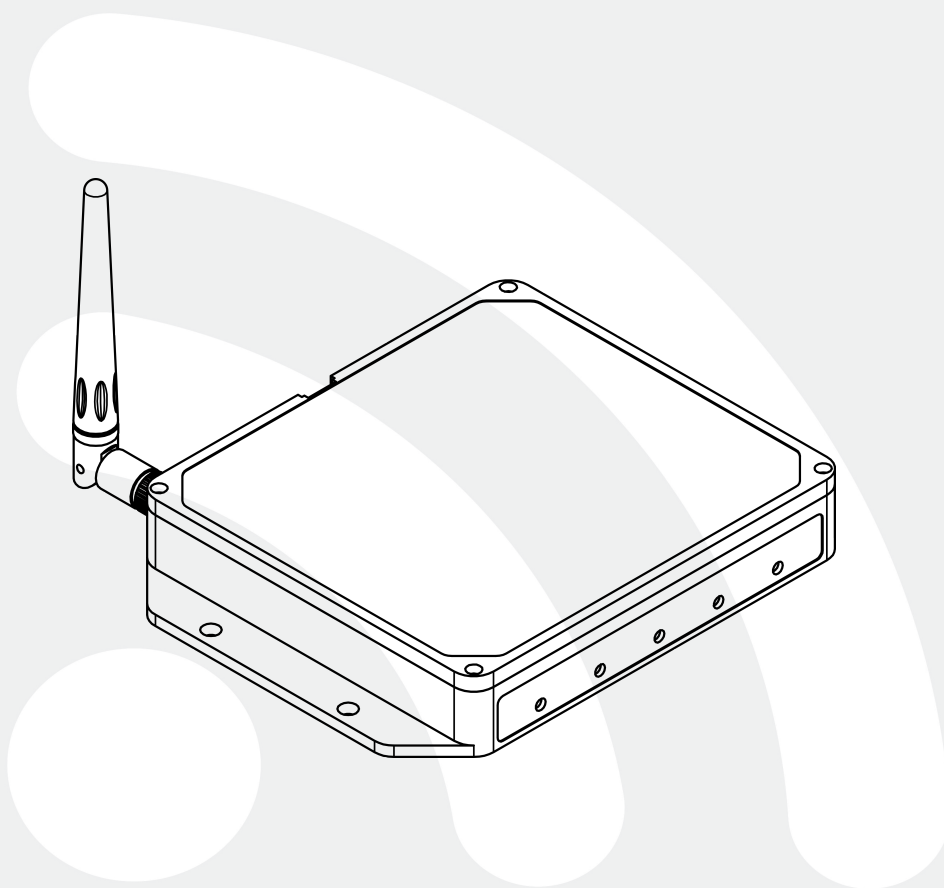



LORD Sensing Systems  
459 Hurricane Lane  
Suite 102  
Williston, VT 05495  
United States of America

**Phone:** 802-862-6629

**Fax:** 802-863-4093

9:00 AM to 5:00 PM (Eastern Time US & Canada)

<http://www.microstrain.com>  
[sensing\\_support@LORD.com](mailto:sensing_support@LORD.com)  
[sensing\\_sales@LORD.com](mailto:sensing_sales@LORD.com)

Document 8500-0090 Revision B

Subject to change without notice.

## Table of Contents

---

<b>1. Wireless Sensor Network Overview</b> .....	<b>6</b>
<b>2. Gateway Overview</b> .....	<b>7</b>
2.1 Gateway Components .....	8
2.2 Gateway Interface .....	9
<b>3. System Operation</b> .....	<b>10</b>
3.1 Software Installation .....	10
3.2 System Connections .....	11
3.3 Protocols and Ports .....	12
3.4 Gateway Operation .....	12
3.5 Gateway Communication .....	13
3.6 Gateway Settings .....	14
3.6.1 Access WSDA Control Panel .....	14
3.6.2 Change Transmit Power .....	16
3.6.3 Change Frequency .....	16
<b>4. Gateway Menu Navigation</b> .....	<b>18</b>
4.1 Gateway Information .....	18
4.1.1 About the Gateway .....	18
4.1.2 Node List .....	20
4.2 Data Options Menu .....	21
4.2.1 CAN J1939 Output .....	22
4.2.2 J1939 Bus Configuration .....	22
4.2.3 Data Alias Definitions .....	29
4.2.4 SensorCloud™ Upload Filter .....	31
4.2.5 WSDA Data Downloader Calibration Coefficients .....	32
4.2.6 Clear Stored Data .....	34
4.3 Gateway Tools Menu .....	34

---

4.3.1	<i>Diagnostics</i>	35
4.3.2	<i>Configuration</i>	36
4.3.3	<i>Time Options</i>	39
4.3.4	<i>Reboot</i>	41
4.3.5	<i>Operating System (OS) Upgrade</i>	42
4.3.6	<i>Change Password</i>	43
<b>5.</b>	<b>Remote Connectivity</b>	<b>44</b>
<b>6.</b>	<b>Using the Beacon</b>	<b>47</b>
6.1	System Bandwidth in Synchronized Sampling	48
6.2	Synchronized Sampling with Multiple Gateways	48
<b>7.</b>	<b>Sensor Node Access</b>	<b>49</b>
7.1	Connect to Nodes	49
7.1.1	<i>Automatic Node Discovery on Same Frequency</i>	49
7.1.2	<i>Automatic Node Discovery on Different Frequency</i>	49
7.1.3	<i>Manually Add Node</i>	51
7.2	Configure Node	52
7.3	Configure and Start Sampling	53
<b>8.</b>	<b>Viewing Data</b>	<b>57</b>
8.1	SensorCloud	57
<b>8.</b>	<b>Data Handling</b>	<b>58</b>
8.1.1	<i>Navigating Menus</i>	58
8.2	SensorConnect	60
8.2.1	<i>Using Dashboards and Widgets</i>	60
8.2.2	<i>Navigating Graphs</i>	61
8.2.3	<i>Widgets Options</i>	61
8.2.4	<i>Time Series Widget Menu</i>	62
8.2.5	<i>Exporting Data Files</i>	63

---

8.3 Using the Data Downloader .....	63
<b>9. Gateway Installation .....</b>	<b>67</b>
9.1 Installation Recommendations .....	67
9.1.1 Range Test .....	69
9.2 Multi-port Connector Interface .....	70
9.3 Gateway Accessories .....	71
<b>10. Troubleshooting .....</b>	<b>72</b>
10.1 Troubleshooting Guide .....	72
10.2 Communications Ports in Windows® .....	76
<b>11. Wireless Equipment .....</b>	<b>79</b>
11.1 Standard Models .....	79
11.2 Wireless System Equipment .....	79
<b>12. Specifications .....</b>	<b>81</b>
12.1 Physical Specification .....	81
12.2 Operating Specifications .....	82
12.3 Radio Specifications .....	84
<b>13. Safety Information .....</b>	<b>85</b>
13.1 Disposal and Recycling .....	85
<b>14. References .....</b>	<b>86</b>
14.1 Related Documents .....	86
<b>15. Glossary .....</b>	<b>87</b>

## 1. Wireless Sensor Network Overview

The LORD Sensing Wireless Sensor Network is a high-speed, scalable, sensor data acquisition and sensor networking system. Each system consists of wireless sensor interface nodes, a data collection gateway, and full-featured user software platforms based on the LORD Sensing Lossless Extended Range Synchronized (LXRS) and LXRS+ data communications protocols. Bi-directional wireless communication between the node and gateway enables sensor data collection and configuration. Gateways can be connected locally to a host computer or remotely via local and mobile networks. Some gateways also feature analog outputs for porting sensor data directly to stand-alone data acquisition equipment.



The selection of available nodes allows interface with many types of sensors, including accelerometers, strain gauges, pressure transducers, load cells, torque and vibration sensors, magnetometers, 4 to 20 mA sensors, thermocouples, RTD sensors, soil moisture and humidity sensors, inclinometers, and orientation and displacement sensors. Some nodes come with integrated sensing devices such as accelerometers. System sampling capabilities include lossless synchronized sampling, continuous and periodic burst sampling, and data logging. A single gateway can coordinate many nodes of any type, and multiple gateways can be managed from one computer with the SensorConnect™ and SensorCloud™ software platforms. Integration to customer systems can be accomplished using OEM versions of the sensor nodes and leveraging the LORD Sensing data communications protocol.

Common wireless applications of LORD Sensing Sensing Systems are strain sensor measurement, accelerometer platforms, vibration monitoring, energy monitoring, environmental monitoring, and temperature monitoring.

## 2. Gateway Overview

The WSDA-2000 is a data acquisition gateway designed to configure, co-ordinate, and collect sensor data from LORD Sensing wireless sensor nodes. The gateway supports all data acquisition sessions between wireless nodes and host computers including: continuous sampling, burst sampling, and datalogging. The gateway also facilitates precision sampling synchronization between sensor nodes by transmitting a continuous, system-wide timing reference known as the beacon. Communication between the nodes and gateway is wireless and uses the LORD Sensing LXRS and LXRS+ data communications protocols.

The WSDA-2000 utilizes Ethernet and USB interfaces to transfer data from the wireless nodes to a host computer for viewing, analysis, and storage. It also provides a CAN data output.



Figure 1 - WSDA-2000

## 2.1 Gateway Components

The WSDA-2000 can be purchased individually or in a starter kit. The kit includes everything required to operate the WSDA-2000 including a removable external antenna, a power supply, and cables for interfacing with the host computer or network. For a complete list of available configurations, accessories, additional system products, and ordering information [see \*Wireless Equipment on page 79\*](#).

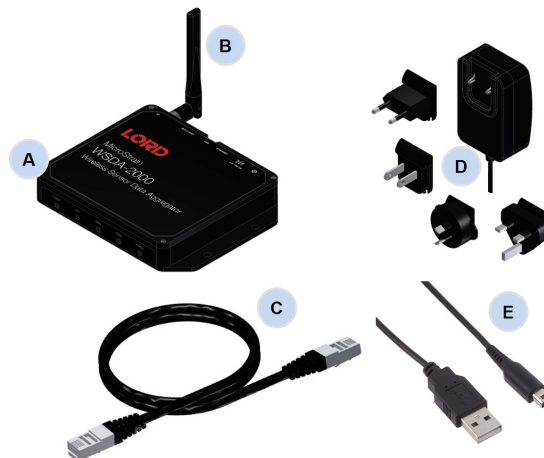

Item	Description
A	WSDA-2000
B	Antenna
C	Ethernet cable, 10 ft
D	Power supply & plug adapter kit
E	USB cable
--	SensorConnect download at: <a href="http://www.microstrain.com/software">http://www.- microstrain.com/software</a>

Figure 2 - Starter Kit Components



## 2.2 Gateway Interface

The WSDA-2000 interfaces include a power input jack , a power on/off switch, an antenna connector for attaching the gateway antenna, an Ethernet jack, a multi-use (multi-port) connector, and a USB port. The indicators on the WSDA-2000 include several device and data status indicators, and a power indicator. The following table describes basic indicator behavior. For a complete list of all indicator behaviors [see Device Status Indicators on page 1](#).

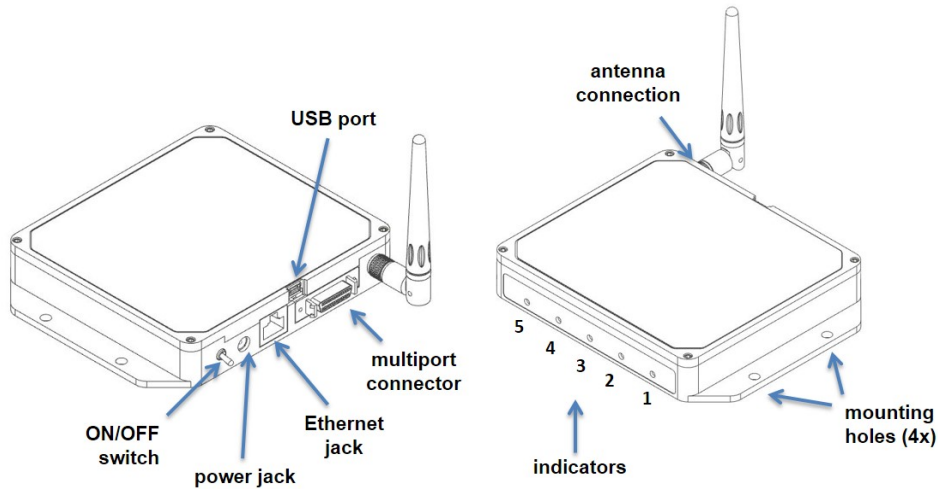

Figure 3 - Ports and Indicators

Indicator	Behavior	Node Status
1. POWER	OFF	Gateway is off
	ON green	Gateway is on
2. WSDA	ON green	Fully booted & idle
	Flashing blue & green	Sampling and porting data through SensorConnect™
3. DATA	Flashing green	Receiving wireless data
	Flashing blue	Sync sampling beacon enabled
	Flashing red	WARNING: another gateway beacon is detected on the same frequency
4. ACT	--	(future use)
5. CLOUD	Flashing blue	Uploading data to SensorCloud™
	ON green	Web upload successful
	ON red	Web upload error

Table 1 - Basic Indicator Behaviors

### 3. System Operation

The WSDA-2000 is an advanced gateway that aggregates LORD Sensing wireless data and interfaces LORD Sensing wireless networks to SensorCloud™ and data acquisition computers.

LORD Sensing's SensorConnect software program is available for data acquisition from the wireless sensor network. This is a PC-based software used for configuring gateways and nodes, selecting sampling modes and parameters, initializing data acquisition, and viewing and saving data.

#### 3.1 Software Installation

Install the **SensorConnect** software on the host computer before connecting any hardware. Access the free software download on the LORD Sensing website at:



<http://www.microstrain.com/software>

**SensorCloud** is an optional data collection, visualization, analysis, and remote management tool. It is based on cloud computing technology and is accessed directly from a web connection. For more information go to: <http://www.sensorcloud.com/>.



## 3.2 System Connections

To acquire sensor data the following components are needed: a LORD Sensing wireless sensor node, a LORD Sensing data gateway, and a host computer with access to the data acquisition software.

The sensor, node, gateway, and software selection are application-dependent, but the basic interfaces are the same. The WSDA-2000 gateway utilizes Ethernet communications and can be used with SensorConnect and SensorCloud™, although system configuration is completed using SensorConnect. For a connections overview using the WSDA-2000 refer to [Figure 4 - System Connections](#).

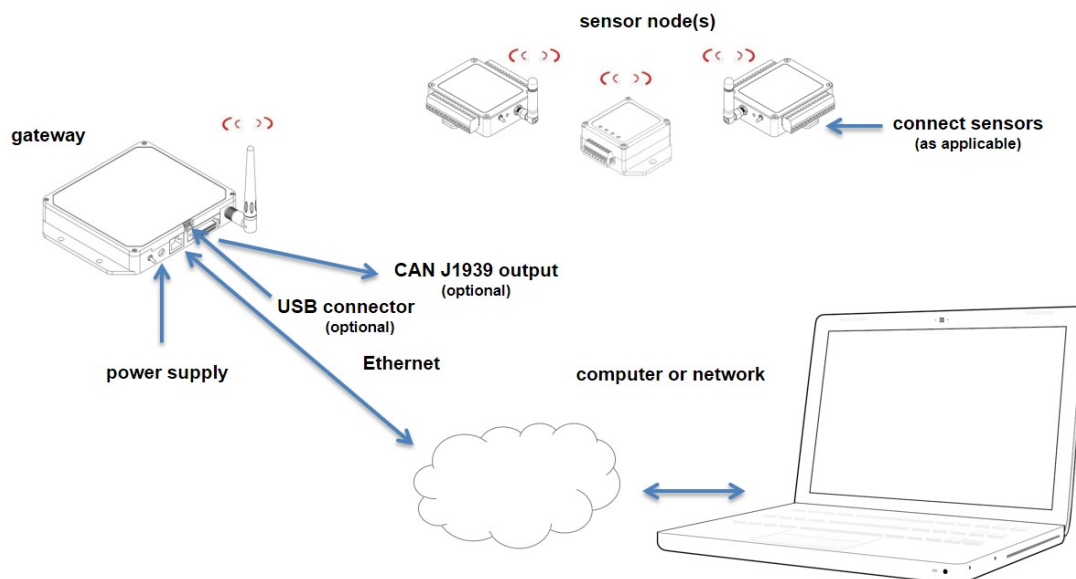

Figure 4 - System Connections

### 3.3 Protocols and Ports

This is an overview of high-level networking activity for WSDA-2000 services. Excludes low-level services like DHCP, ARP and DNS.

Function	Protocol	Network Port
SensorCloud Communication	HTTPS requests to sensorcloud.microstrain.com and *.sensorcloud.microstrain.com	TCP 443
Network Time Synchronization	NTP to user configurable time server	TCP 123
Network Discovery	UPnP	UDP 1900 and TCP 80
Control Panel (local)	HTTP server	TCP 80
Control Panel (remote)	Secure WebSocket connection to lc.sensorcloud.microstrain.com	TCP 443
	HTTPS requests to sensorcloud.microstrain.com	TCP 443
TCP LiveConnect (local)	TCP server	TCP 5000
UDP LiveConnect (local)	Configurable unicast or multicast destination	TCP 443
LiveConnect (remote)	HTTPS requests to sensorcloud.microstrain.com	TCP 443

### 3.4 Gateway Operation

#### NOTE

The default configuration of Ethernet gateways is for DHCP network connectivity. If no DHCP network is available, the USB port can be used for most operations, including device configuration, local data acquisition, and to access the network configuration menu (WSDA Control Panel). SensorConnect detects USB devices automatically and adds them to the Devices list.

The Ethernet gateway has three primary operating sequences including gateway configuration, node configuration, and data acquisition, viewing and analysis.

### 3.5 Gateway Communication

- a. Power is applied to the gateway through the power jack on the back of the WSDA-2000. The Ethernet jack is connected to the network using a CAT5 or better Ethernet cable.
- b. Open the SensorConnect™ software and select Add Device
- c. Select the gateway and confirm the IP address shows in the IP Address field. The IP address can be entered manually in the IP Address field above the Discovered Gateways section. If the gateway does not appear, confirm that the host computer and the gateway are connected to the same Ethernet network.

USB devices are automatically discovered when plugged in.  
To add a TCP/IP or Serial device, use the form below.

Connection: TCP/IP

IP Address: 10.42.0.109

Port: 5000

Name	IP Address	Port
W015000000045109	10.42.0.109	5000

Add Device

Figure 5 - Adding A Device

- d. Select the green Add Device button.
- e. The gateway will appear in the Controller window.



Figure 6 - Gateway Communication

## 3.6 Gateway Settings

### 3.6.1 Access WSDA Control Panel

The WSDA Control Panel menu provides access to gateway network settings, time synchronization options, CAN output configuration, and more. To view the WSDA Control Panel, from the Devices window, highlight the base station and select the WSDA Control Panel tile.



Figure 7 - Control Panel Access

Log in to the gateway Control Panel with the default credentials:

- Login: wsda
- Password: wsda

A navigation panel on the left shows three menu categories: General, Data, and Tools.



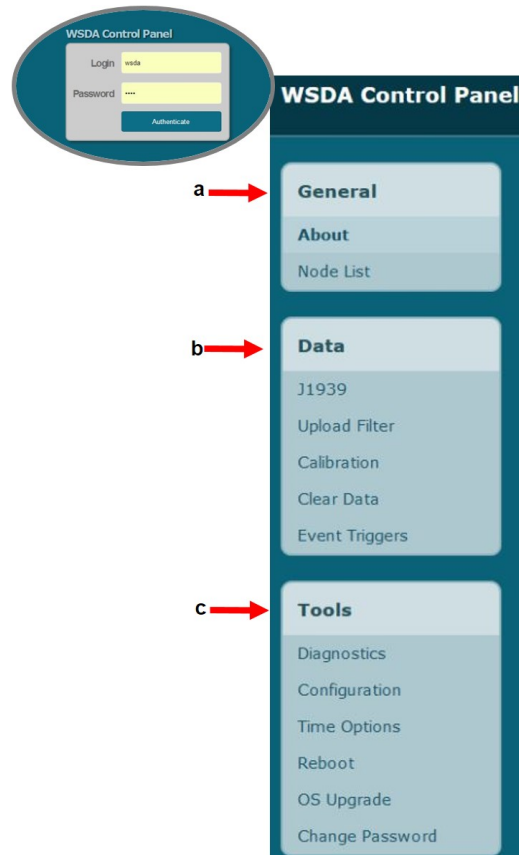

**Figure 8 - Control Panel Menus**

- a. **General** - This category includes menu selections for information about the gateway's identity and time settings (About) and the sensor nodes it currently has data for in memory (Node List).
- b. **Data** - This category includes menu selections that allow users to set which node and channel data is uploaded to SensorCloud™ (Upload Filter), set which data is pushed out the CAN J1939 port (J1939), apply calibration coefficients to data downloaded from the gateway internal memory (Calibration), and clear data from the device internal memory (Clear Data).
- c. **Tools** - This category includes menu selections for troubleshooting the gateway (Diagnostics); configuring communication settings, enabling and disabling operating sequences, changing the node synchronization beacon state, and changing the gateway radio frequency (Configuration); configuring system time (Time Options); rebooting the gateway (Reboot); updating the operating system (OS Upgrade); and changing the Control Panel log-in (Change Password).

### 3.6.2 Change Transmit Power

From the Base Station, select Configure > Transmit Power for a drop down menu of five power options ranging from 0 dBm to 20 dBm.

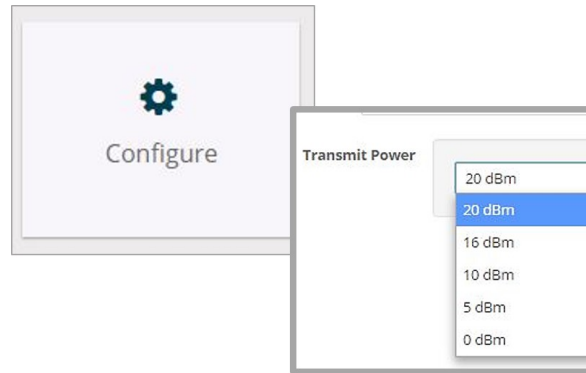

Figure 9 - Transmit Power Setting

### 3.6.3 Change Frequency

There are 16 available frequency channels between 2.405 and 2.480 GHz. Wireless nodes and the gateway must be on the same frequency channel to communicate.

To move the gateway to a different frequency, select Base Station and then the Change Frequency tile. To move the node to the same frequency, select the Nodes on Other Frequencies tile after the gateway has been changed.

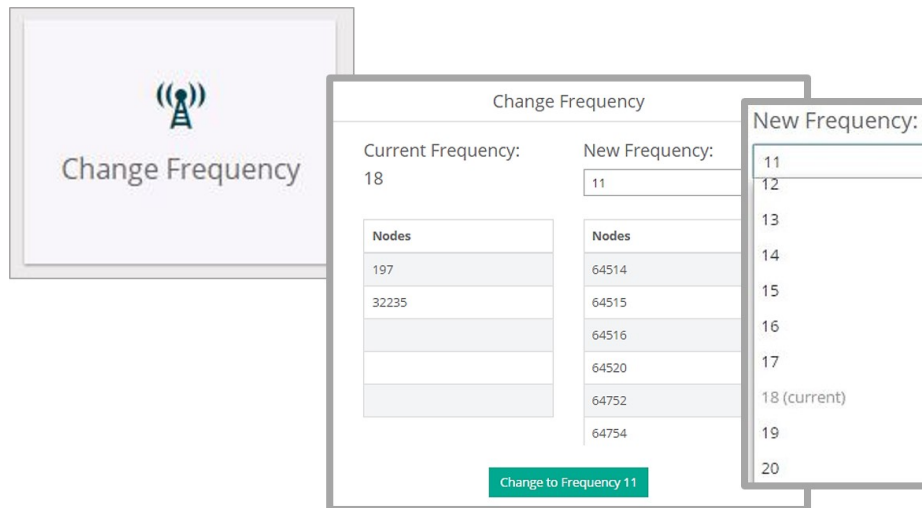

Figure 10 - Gateway Frequency



**NOTE**

Setting the transmit frequency using SensorConnect is temporary for Ethernet gateways and will revert back to the frequency setting selected in the gateway Control Panel when the gateway is powered off or rebooted ([see Gateway Settings on page 14](#) for how to change the frequency setting in Control Panel)

## 4. Gateway Menu Navigation

### 4.1 Gateway Information

The General category provides information about the gateway identity, the wireless nodes it serves, and its current time settings. These are informational only, and no user adjustments may be made in these menus. [Table 2 - General Menus](#) provides a summary of the menus under the General category.

Menu	Description
About	Provides information about the gateway identity
Node List	Displays a list of wireless nodes for which the gateway is currently storing data
Time Settings	Provides time-related information

Table 2 - General Menus

#### 4.1.1 About the Gateway

The About menu provides information about the gateway. Each item is defined below.

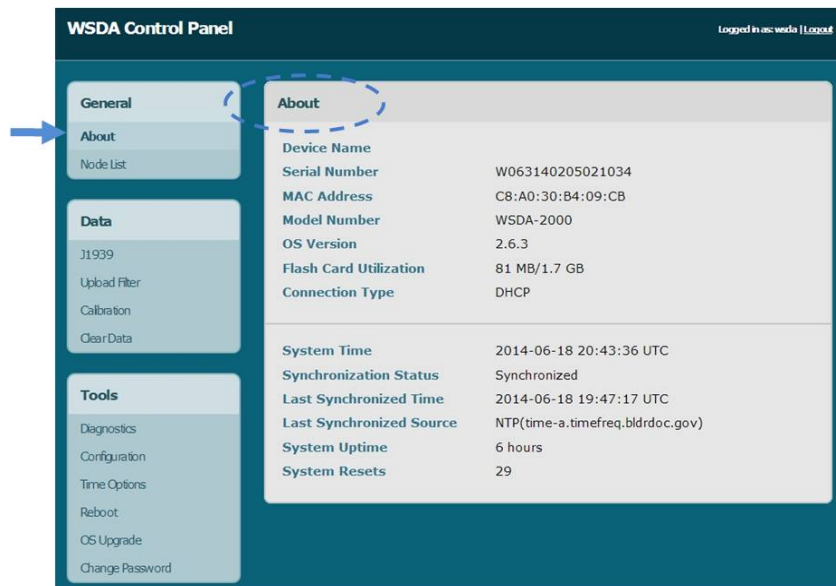

Figure 11 - About Menu

**Device Name:** an alias given to the WSDA-2000 so that it is more easily recognized in Live Connect. By default, the device name is not assigned, and Live Connect will use the device serial number as an identifier. The device name can be changed in the Tool > Configuration menu ([see Configuration on page 36](#)).

**Serial Number:** an alpha-numeric identifier embedded in the WSDA-2000 hardware. The serial number is assigned when the gateway is manufactured.

**MAC Address:** an alpha-numeric identifier embedded in the network card of the WSDA-2000 hardware. A MAC (Media Access Control) Address is a unique identifier assigned to all Ethernet devices to manage communications on the network. The MAC address is assigned when the gateway is manufactured.

**Model Number:** an alpha-numeric identifier used to identify the gateway type. The model number is assigned when the gateway is manufactured.

**OS Version:** a numeric identifier used to identify the WSDA-2000 OS (Operating System) Version. The OS is the on-board software that operates the WSDA-2000. All gateways are shipped with the current OS version. As new features are added, OS updates are available from LORD Sensing Technical Support ([see \*Technical Support on page 78\*](#)) and installed by the user through the Tools > OS Upgrade menu ([see \*Operating System \(OS\) Upgrade on page 42\*](#)).

**Flash Card Utilization:** the amount of memory currently consumed by data in the gateway internal memory, and the total memory capacity. Data received from sensor nodes is stored here. When capacity is reached, the flash card will begin overwriting data on a first-in, first-out basis (older data is overwritten first).

**Connection Type:** the type of Ethernet connection the gateway is currently configured for - DHCP or Static IP. This option and other settings can be changed in the Tools > Configuration menu ([see \*Configuration on page 36\*](#)).

**System Time:** the current UTC time on-board the WSDA-2000 system clock. UTC (Coordinated Universal Time) is the time standard by which the world regulates clocks and time. The system clock is normally updated from internet time servers every 12 hours. For a more detailed discussion of the system and real time clocks [see \*Time Options on page 39\*](#).

**Synchronization Status:** the WSDA-2000 is considered to be Synchronized if it has successfully synchronized to one of its enabled time sources since it was booted, and before any periodic synchronization has expired. Otherwise is considered to be Not Synchronized. For a more detailed discussion of the system and real time clocks [see \*Time Options on page 39\*](#).

**Last Synchronized Time:** the most recent time when the gateway was synchronized to a time source

**Last Synchronized Source:** the source from which the most recent time synchronization occurred

**System Up-time:** the elapsed time since the gateway was last powered on and booted up. The system up-time will be zeroed when the gateway power is cycled or it is rebooted from the Tools > Reboot menu.

**System Resets:** the number of times the gateway has been reset. System Resets will be incremented when the gateway power is cycled or it is rebooted from the Tools > Reboot menu. System Resets are written to non-volatile memory and is preserved through power outages.

## 4.1.2 Node List

The node list displays all the wireless nodes that have data currently stored in the gateway memory. The node address is shown along with the sensor channels that were configured to transmit data to the gateway, the relative timestamp (time since the node sent its first data to the gateway), and the last timestamp (the time of the most recent node data received by the gateway).

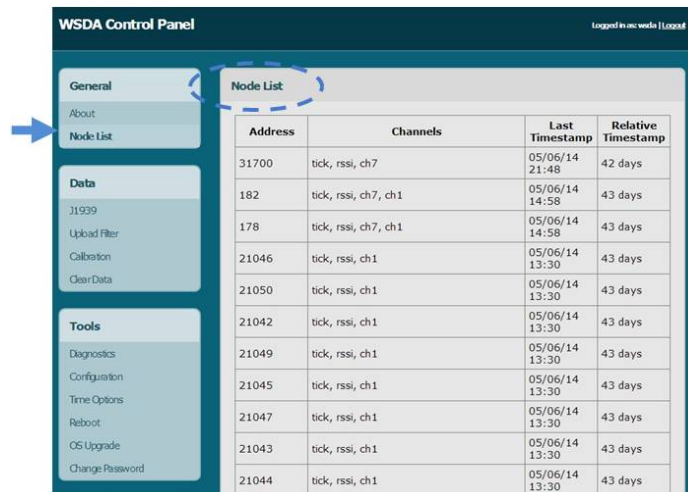

Address	Channels	Last Timestamp	Relative Timestamp
31700	tick, rssi, ch7	05/06/14 21:48	42 days
182	tick, rssi, ch7, ch1	05/06/14 14:58	43 days
178	tick, rssi, ch7, ch1	05/06/14 14:58	43 days
21046	tick, rssi, ch1	05/06/14 13:30	43 days
21050	tick, rssi, ch1	05/06/14 13:30	43 days
21042	tick, rssi, ch1	05/06/14 13:30	43 days
21049	tick, rssi, ch1	05/06/14 13:30	43 days
21045	tick, rssi, ch1	05/06/14 13:30	43 days
21047	tick, rssi, ch1	05/06/14 13:30	43 days
21043	tick, rssi, ch1	05/06/14 13:30	43 days
21044	tick, rssi, ch1	05/06/14 13:30	43 days

Figure 12 - Node List

## 4.2 Data Options Menu

The Data category provides data handling options such as selecting which data is sent to the CAN J1939 bus, uploaded to SensorCloud™, and downloaded to a host computer. Data can also be cleared from the WSDA-2000 internal memory. [Table 3 - Data Menus](#) provides a summary of the menus under the Data category.

Menu	Description
J1939	Enable and select what sensor data is sent out in CAN J1939 format and what method is used
Upload Filter	Select which sensor nodes and channels are uploaded to SensorCloud™
Calibration	Apply calibration conversions values and select measurement display units before downloading saved data
Clear Data	Erase data from the gateway flash memory

**Table 3 - Data Menus**

Nomenclature for node address, channel assignments, and other data are used in some of the Data menus. [Table 4 - Data Nomenclature](#) describes the required naming conventions for these assignments. Node information found in the Node List are also annotated this way ([see Node List on page 20](#)).

Field	Description	Nomenclature	Examples
Address	Node address assigned when the node is manufactured. Provided with the node and displayed in SensorConnect when connected	decimal number	31463
Channel Channel List Payload	Data and packet value aliases such as for node address, node channel number, radio strength, and protocol values. Channel number assignment is handled in SensorConnect. All other aliases are fixed ( <a href="#">see Data Alias Definitions on page 29</a> ).	lower case text followed by a number. In a channel list multiple values are separated by a comma or space	ch1 ch1,ch2,ch5, bin 1 , rssi ch2 angleid

**Table 4 - Data Nomenclature**

## 4.2.1 CAN J1939 Output

In addition to saving locally or uploading through an Ethernet connection, data acquired from sensor nodes can also be pushed onto a CAN J1939 bus for reactive command and control of external devices and other applications. By default the output is disabled. Enable the output in the Tools > Configuration menu [see Configuration on page 36](#).

The J1939 menu includes CAN communication settings (J1939 Bus Configuration) and output messages configuration (J1939 Broadcast Message Configuration) ([see CAN J1939 and Bit Rate Menu on page 22](#)).

## 4.2.2 J1939 Bus Configuration

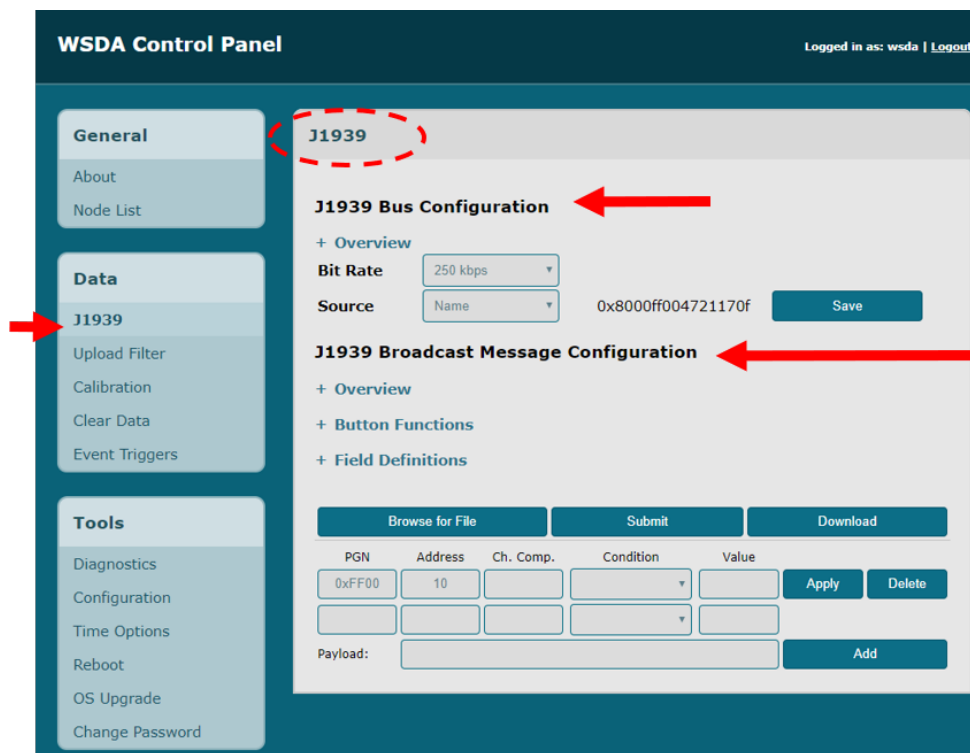

Figure 13 - CAN J1939 and Bit Rate Menu

The bus configuration settings include the **Bit Rate** and data **Source**.

The bit rate is set as required by the host CAN bus that the gateway is integrated with. The default is 250 kilobits per second (kbps), which is typical for most applications.

**NOTE**

The wireless data transmit rate (between the node and the gateway) directly impacts the data bandwidth on the CAN bus. If the aggregate transmit rate of the wireless network (combined bandwidth use of active nodes) is high enough and there are other devices (besides the gateway) on the CAN bus, the bus may be overwhelmed, resulting in lost data. **The gateway settings provide no limitations to how much data is pushed onto the bus.** If there are no other devices on the CAN bus, this is not an issue, however it is up to the user to determine the amount of data the bus can handle from each device. Increasing the CAN bus bit rate and adjusting sensor sampling settings, such as reducing sample rates and period, can be used to alleviate CAN bus bandwidth limitations.

The Source setting refers to where the data is coming from, as in, how the WSDA-2000 will be recognized and addressed on the CAN bus ([Figure 14 - Data Source Setting](#)).

- By setting the source to **Name**, the gateway will acquire an address dynamically by requesting it in sequential order, within the dynamic address range, until no other device contests it ([Table 5 - WSDA-2000 J1939 Values](#)).
- By setting the source to **Address**, the user can assign a static address within the gateway address range ([Table 5 - WSDA-2000 J1939 Values](#)). This address is typed in the field next to the Source field, in place of the name.

The image shows two overlapping screenshots of the 'J1939 Bus Configuration' interface. The top-left screenshot shows the 'Overview' section with 'Bit Rate' set to 500 kbps and 'Source' set to 'Name'. The bottom-right screenshot shows the 'Overview' section with 'Bit Rate' set to 500 kbps, 'Source' set to 'Address', and a text input field containing '0x80' with a 'Save' button next to it.

**Figure 14 - Data Source Setting**

With either setting, the gateway will be identified by the name assigned to it when manufactured (which is displayed to the right of the Source selection menu). This name provides the host CAN bus with information about the device that determines its data priority relative to other devices on the bus ([Table 5 - WSDA-2000 J1939 Values](#)).

Description	Range
<b>J1939 name (assigned when manufactured)</b>	0x8000FF0047200000 to 0x8000FF00473FFFFFFF
<b>J1939 bus bit rate (user setting)</b>	250 kbps (default), 500 kbps, 1 Mbps
<b>J1939 dynamic address range (Source set to Name)</b>	0x80 to 0xCF
<b>J1939 static address range (Source set to Address)</b>	0x00 to 0xFF
<b>Broadcast message PGN range (Destination set to None)</b>	0xFF00 to 0xFFFF

**Table 5 - WSDA-2000 J1939 Values**

To change any of the settings, select from the drop down menus for each one and then select the Save button to save the selected settings ([Figure 14 - Data Source Setting](#)).



## Broadcast Message Configuration

The J1939 Broadcast Message Configuration section provides a form for the user to define J1939 broadcast messages. Broadcast messages are messages sent to the broadcast address (0xFF). The user must specify a unique identifier for each packet called the Parameter Group Name (PGN). This value is up to the user to select but must be within the range allowed (0xFF00 through 0xFFFF). Additionally, the user must also define which data values the WSDA should forward onto the bus for each given PGN and under which conditions.

To define which data to send for a given PGN, the user must specify the address of the wireless node producing the data and the name of each data stream from that node which should be forwarded onto the bus. If the user only wants to forward data when a certain condition is met, the user may specify which data stream to use for the conditional (e.g. ch1), what condition to use (e.g. is greater than), and the value for the comparison (e.g. 4.0). Otherwise, these fields may be left blank ( *See Broadcast Message Menu Example on page 27* ). The wireless node must also be capable of producing the specified information and configured to do so.

Field	Description	Format	Range
<b>PGN</b>	SAE CAN J1939 Identifier	hexadecimal	0xFF00 to 0xFFFF
<b>Address</b>	sensor node address	decimal	1 to 65534
		hexadecimal	0x0001 to 0xFFFE
<b>Payload</b>	list of packet alias values	text separated by spaces	(example:ch1 ch2)
<b>Ch Comp</b>	channel for conditional formula	text	(example:ch1)
<b>Condition</b>	condition for conditional formula	mathematical operator	in range*, <, >, =, ≠
<b>Value</b>	threshold for conditional formula	single precision floating point	decimals within format constraint

\* For the "in range" option, the Value field is two values separated by a comma (ex. 4,5), ordered from least to greatest. The values listed are included in the comparison.

**Table 6 - Broadcast Message Configuration Fields**

**PGN:** (Parameter Group Name) unique hexadecimal packet identifier

**Address:** is the numerical address of the sensor node the data to be sent is from. The node address is assigned when the node is manufactured. The number is provided with the node and displayed in SensorConnect when connected.

**Payload:** Payload are the data values to include in the packet. They are listed by name in the sequence they will be sent. If the requested value cannot be found (for example, if the nomenclature is wrong) the defined J1939 packet will not be sent. [See Data Alias Definitions on page 29](#) for the payload nomenclature. The size (in bytes) of each value depends on the node settings. The byte counts are defined in the packet definitions which can be found on [Github](#). Possible value names can be listed by clicking on the "Payload" text box and pressing the down arrow on the keyboard.

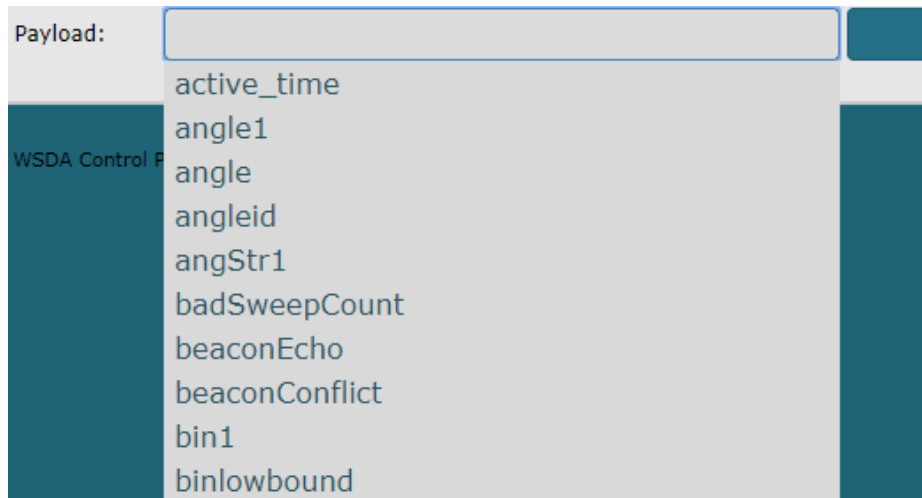

**Table 7 - Payload Values Menu**

**Ch Comp, Condition and Value:** Use these fields to create a condition for which packets will be sent onto the CAN bus. Ch Comp (Channel Compare) is the data source for the condition formula, and the Condition and Value define what mathematical operation to apply to it.

To **enter the broadcast messages** in the J1939 menu, type in the appropriate field. When the PGN field is selected, the Payload field will appear. If all values for the message are to be included, leave the Ch. Comp, Condition and Value fields blank. Select Apply at the end of the row to save the message designations. Once all designations are entered, click the Submit button to save the configuration (Figure 13 - CAN J1939 and Bit Rate Menu). To save the configuration for future use, download to a file using the Download button.

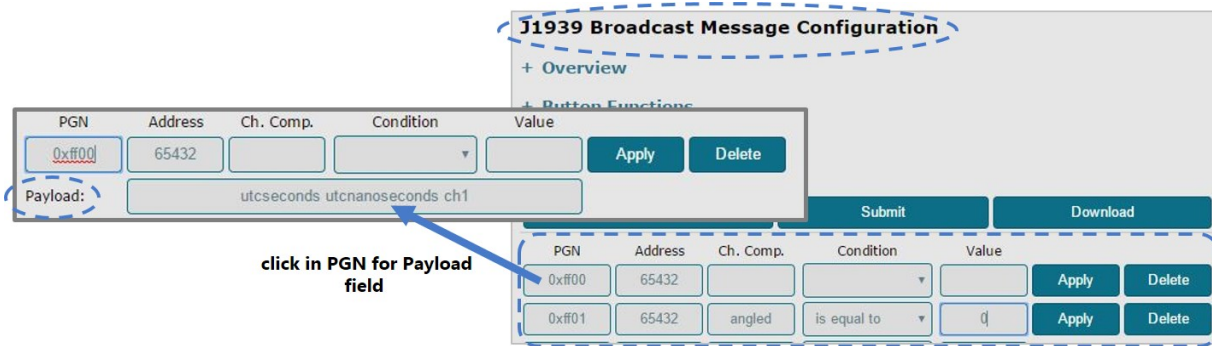

Figure 15 - Broadcast Message Menu Example

To **use a text file**, structure the data in the following format. Leave fields blank if all values are to be included.

```
[PGM]
NodeAddress= value
Protocol= value
Variant= value
Payload= value
Condition= channel name:operator.value
```

**EXAMPLE:**

Node 31463 was sampled in low duty cycle mode. Sensors are connected to channel 1, channel 2, and channel 3. For channels 1 and 3 all data measurements will be sent to the CAN bus. For the sensor on channel 2, only data values over 1.8 will be sent.

```
[0xFF00]
NodeAddress=31463
Protocol=4
Payload=ch1 ch3

[0xFF01]
NodeAddress=35
Protocol=4
Payload=ch2
Condition=ch2:>:1.8
```

Once created, save the text file and then upload it to the gateway by clicking the Browse for File button in the J1939 menu. Navigate to the file, click OK, and then click the Submit button to save the configuration (*Figure 16 - Upload Configuration File*).

PGN	Address	Ch. Comp.	Condition	Value	Apply	Delete
0xff00	65432				Apply	Delete
0xff01	65432				Apply	Delete

Figure 16 - Upload Configuration File

In the example below, ch1 and the value 1 are used to demonstrate the acceptable values for the **Condition syntax**.

**In range:**

Condition = ch1:in:1,5

**Equal to:**

Condition= ch1:=:1

**Greater than:**

Condition = ch1:>:1

**Less than:**

Condition = ch1:<:1

**Not equal to:**

Condition = ch1!:=:1

**Host Bus Integration**

○ **Broadcast Messages:**

With this message format, the receiving system will need to be programmed to understand the user defined payloads for each PGN sent. Specifically, the user will need to inform the receiving system which order the data values are stored in the payload and how many bytes each data value is made up of.

### 4.2.3 Data Alias Definitions

The names of data the sensor network produces and the WSDA can push onto the CAN bus are defined below. All data is in big-endian format unless otherwise noted. Some data channels have fixed sizes or depend on the node settings. Note: The Payload field of the Broadcast Message Menu will also suggest values based on user-set configurations. To view the full list, select Payload and hold while pressing the down arrow on the keyboard ([See CAN J1939 Output on page 22](#)). For Packet definitions and details on the data included in each packet, go to: [Github](#).

Value	Definition	Applicable Packet
<b>angle</b>	The angle for which data is being collected	Structural Health (v1, v2, v3)
<b>angle1 through angle16</b>	The angle for which data is being collected	Raw Angle Strain (Distributed Angle Mode)
<b>angleid</b>	Angle ID specified in the histogram packet	Structural Health (v1)
<b>angStr1 through angStr16</b>	Strain for an angle	Raw Angle Strain Specific Angle Mode, Distributed Angle Mode
<b>beaconConflict</b>	Timestamp from a conflicting wireless beacon	Beacon Echo Packet (v1)
<b>beaconEcho</b>	Timestamp from wireless beacon	Beacon Echo Packet (v1)
<b>bin1 through bin21</b>	Individual bins of histogram	Structural Health (v1,v2)
<b>binlowbound</b>	Low end of stress histogram starts at as specified in the histogram packet	Structural Health (v1,v2)
<b>binsize</b>	Size of each bin as specified in the histogram packet	Structural Health (v1,v2)
<b>bit</b>	The built-in test reported by the node	Diagnostic Packet (v1)
<b>cf1 through cf16</b>	Crest factor for specified channel	Derived LDC Packet (v1), Derived Synchronized Sampling Packet (v1)
<b>ch1 through ch16</b>	Raw data channels (ex. ch4, is the fourth channel of data)	LDC, Synchronized Sampling (v1, v2)
<b>dg1 through dg16</b>	Digital channels	Asynchronous Digital Only
<b>hist</b>	Histogram	Structural Health (v1, v2, v3)
<b>ips1 through ips16</b>	Velocity of specified channel in inches per second	Derived LDC Packet (v1), Derived Synchronized Sampling Packet (v1)
<b>life</b>	Fatigue life used as specified in the histogram packet	Structural Health (v1,v2)
<b>mean1 through mean16</b>	The average (mean) value of specified channel	Derived LDC Packet (v1), Derived Synchronized Sampling Packet (v1)
<b>noderssi</b>	RSSI value of node	Synchronized Sampling (v1,v2), Derived Synchronized Sampling (v1), Asynchronous (v1), Asynchronous Digital and Analog (v1), Structural Health (v2), Diagnostic (V1)
<b>proc_rate</b>	Sample rate of data behind the histogram	Structural Health (v2)

Value	Definition	Applicable Packet
<b>ptp1 through ptp16</b>	Peak-to-peak value of specified channel	Derived LDC Packet (v1), Derived Synchronized Sampling Packet (v1)
<b>rms1 through rms16</b>	RMS value of specified channel (ex. rms1 is rms value of channel 1)	Derived LDC Packet (v1), Derived Synchronized Sampling Packet (v1)
<b>samplerate</b>	Speed of data sampling	LDC (v1,v2), Synchronized Sampling (v1,v2), Structural Health (v1,v2), Derived LDC (v1),Derived Synchronized Sampling (v1)
<b>tick</b>	Packet tick number	LDC (v1,v2), Synchronized Sampling (v1,v2), Derived LDC (v1),Derived Synchronized Sampling (v1)
<b>uptime</b>	Uptime as specified in the histogram packet	Structural Health (v1)
<b>utcnanoseconds</b>	Nanoseconds portion of timestamp in data packet	Synchronized Sampling (v1, v2)
<b>utcseconds</b>	Seconds portion of timestamp in data packet	Synchronized Sampling (v1, v2)

**Table 8 - Data Channel Definitions**

The following table summarizes the Diagnostic Channel definitions.

Value	Definition
<b>active_time</b>	Time node spends actively sampling
<b>badSweepCount</b>	Number of bad sweeps (discarded data)
<b>bit</b>	Built in test results
<b>current_state</b>	Current state of the node
<b>droppedPackets</b>	Number of dropped packets
<b>eventindex</b>	Index for number of events
<b>extPwr</b>	External power flag
<b>idle_time</b>	Time the node spends in idle
<b>inactive_time</b>	Time nodes spends inactive
<b>intTmp</b>	Internal temperature
<b>lowBatteryFlag</b>	Low battery warning
<b>reset_counter</b>	Number of resets
<b>secSinceSync</b>	Time since last synchronization
<b>sleep_time</b>	Time node spends in sleep
<b>sweepIndex</b>	Current sweep index
<b>syncFail</b>	Number of synchronization failures
<b>syncRtry</b>	Number of synchronization retries
<b>totalReTx</b>	Total transmission retries
<b>totalTx</b>	Total transmissions

**Table 9 - Diagnostic Channel Definitions**

## 4.2.4 SensorCloud™ Upload Filter

By default, the WSDA - 2000 uploads all sensor data stored in the gateway memory to SensorCloud™. The Upload Filter function allows the user to select the data to be uploaded.

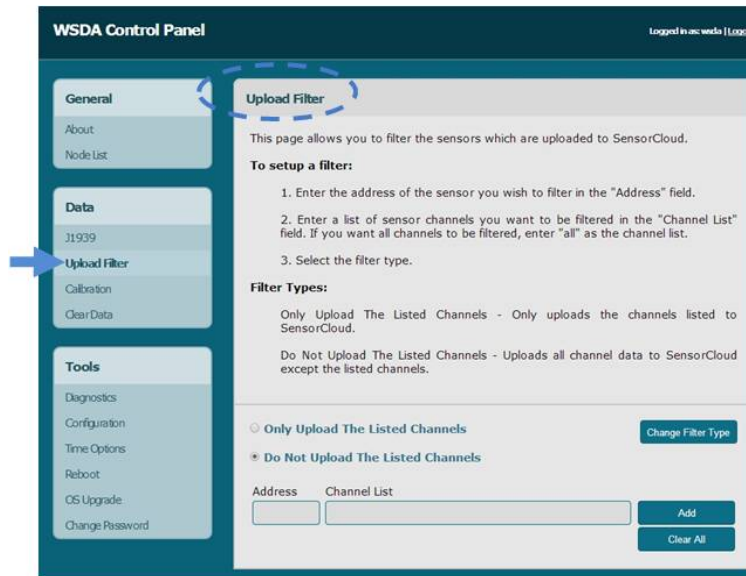

Figure 17 - Data Upload Filter

The Upload Filter menu describes how to set up a filter. Nodes and node channels can be collectively set to be included (Only Upload the Listed Channels) or excluded (Do Not Upload the Listed Channels) by using the Change Filter Type button. For address and channel nomenclature [see Data Options Menu on page 21](#). The Upload Filter can be set before or after data upload has been initiated. If data has already been received from the node, refer to the Node List to verify which node and channel data has been saved. Use the Clear All button to delete all node filters.

### NOTE

The Change Filter Type function affects all nodes in the filter list. When applied, it sets all nodes in the list and cannot be used for individual nodes.

## 4.2.5 WSDA Data Downloader Calibration Coefficients

The Calibration feature allows the user to specify coefficients for converting between engineering units with a linear relationship, and to correct for sensor biases in sensor data saved in the gateway memory.

The coefficients are applied when data is downloaded from the gateway to a host computer using the WSDA Data Downloader and are in addition to any conversion values assigned to the sensor channel during node configuration (*see Channel Configuration on page 1* as well as the applicable node User Manual). This feature is particularly useful for porting collected data into third party applications like Microsoft Excel, custom software, or data analytic software when different coefficients are desired than what was used when the data was acquired.

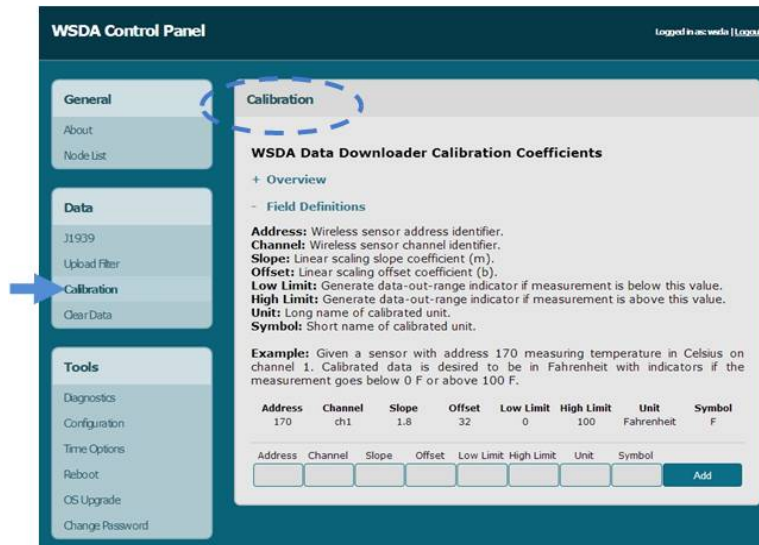

Figure 18 - Calibration Menu

The data to apply the coefficients to is designated by entering the source node address and channel numbers. For the nomenclature used for the address and channel *see Data Options Menu on page 21*. The coefficient values are entered for the designated channels. The values for each are described below and are also available in the calibration help menus accessible by clicking the + symbol next to Field Definitions (*Figure 18 - Calibration Menu*). To use the Calibration feature, click the Add button after entering the desired values in each field.

**Address:** sensor node address

**Channel:** sensor channel on the designated node



The conversion formula assumes a linear relationship between the original units (such as A/D bits) and new engineering units (such as ), and it is expressed mathematically as  $y=mx+b$ , where  $y$  is the engineering units at a given point (measurement),  $m$  is the slope of the line that represents the linear ratio,  $x$  is the original unit value at a given point, and  $b$  is a unit conversion offset (in the case of unit conversions) or the fixed zero load offset of the sensor (in the case of measurement calibration coefficients). Negative values may be entered for any coefficient.

**Slope:** is the linear scaling slope coefficient. The slope is the ratio of original units to new engineering units (EU), and it is used to convert the sensor measurements. The slope conversion value will vary depending on the engineering units desired. For example if the original unit is A/D values (bits), and the desired engineering units are acceleration in  $g$ -force, the slope conversion would describe how many bits equal one unit of  $g$ -force (bits/ $g$ ). Mathematically, the slope is  $m$  in the formula  $y = mx + b$ .

**Offset:** is the linear scaling offset coefficient, and it is typically the starting output value of the sensor with no load applied (in the original units). Mathematically, the offset is  $b$  in  $y = mx + b$ .

**Low Limit:** optional data threshold value that will generate a data-out-range indicator if measurement is below the value

**High Limit:** optional data threshold value that will generate a data-out-of-range indicator if measurement is above the value

**Unit:** user defined long name of calibrated unit

**Symbol:** user defined short name of calibrated unit

**EXAMPLE:**

Sensor node 34163 is measuring temperature in degrees Celsius on channel 1. Calibrated data is desired to be in Fahrenheit with indicators if the measurement goes below 0 F or above 100 F. The conversion for Celsius to Fahrenheit is:  $F = C * 1.8 + 32$  ( $y = mx + b$ )

Address	Channel	Slope	Offset	Low Limit	High Limit	Unit	Symbol
34163	ch1	1.8	32	0	100	Fahrenheit	F

### 4.2.6 Clear Stored Data

The Clear Data feature is used to erase all sensor node data from the gateway's internal memory. Before erasing, the user should confirm that all data has been transmitted to SensorCloud™. The Current Data Size display indicates the amount of data currently stored in the memory. To clear data, click the Clear All Data button and the data will be erased.

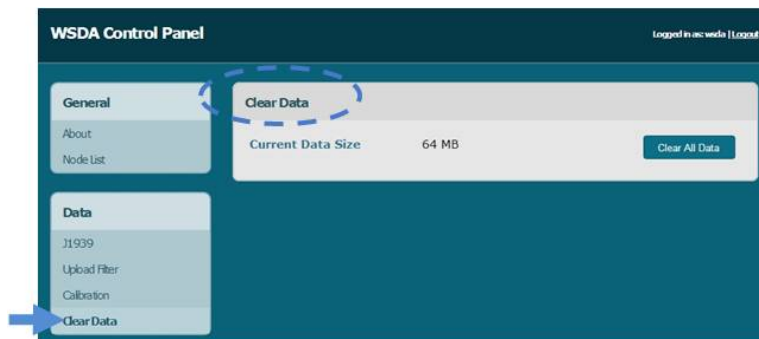

Figure 19 - Clear Data Menu

### 4.3 Gateway Tools Menu

The Tools menus provide the user a means to configure, troubleshoot, and update the WSDA-2000 settings. [Table 10 - Tools Menus](#) provides a summary of the menus under the Tools category.

Menu	Description
Diagnostics	Reports results of periodic diagnostic checks
Configuration	Gateway settings adjustments such as communications configuration, device naming, and enabling and disabling of gateway features
Time Options	Configuration options related to how the gateway retrieves and uses time
Reboot	Restart and reinitialize the gateway without cycling power
OS Upgrade	Update the operating system software on the gateway
Change Password	Change the user name and the password required at log-in to the gateway Control Panel

Table 10 - Tools Menus

### 4.3.1 Diagnostics

The diagnostics feature is used to troubleshoot the WSDA-2000. The diagnostics window displays a report from the gateway internal log file. The log records the diagnostic checks from three possible sources of error: the timing engine, SensorCloud™ data upload, and the data logger. These diagnostic checks are performed once at every power up and then periodically as the gateway is in on. If errors are reported in the Diagnostics menu, contact LORD Sensing Technical Support ([see Technical Support on page 78](#)).

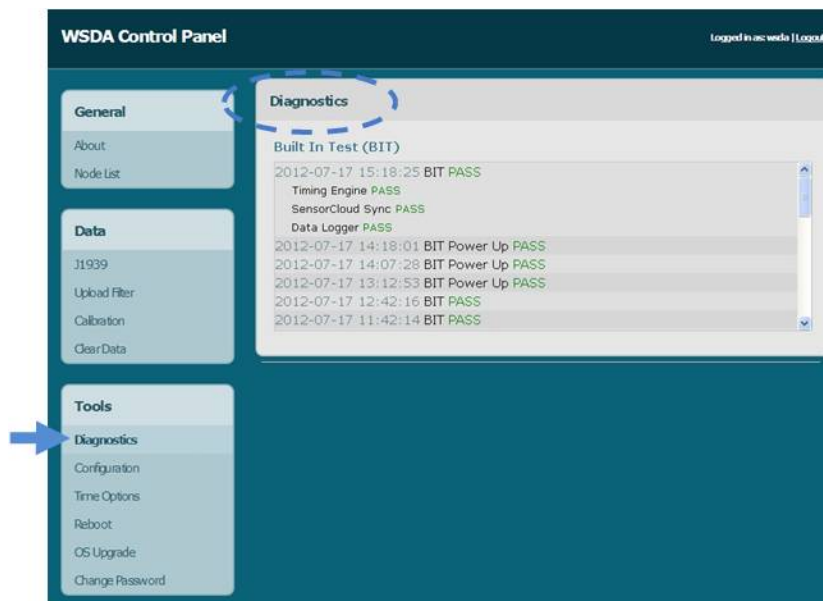

Figure 20 - Diagnostics Menu

#### NOTE

If SensorCloud™ Data Upload, J1939, or Data Logging are disabled (in the Tools > Configuration menu) they will not be checked during the diagnostics routine.

### 4.3.2 Configuration

The Configuration menu allows the user to set parameters associated with WSDA-2000 operation. The settings include configuring the communication settings, enabling and disabling operating sequences, changing the node synchronization beacon state, and changing the gateway wireless node communication frequency. Each setting is described below in detail.

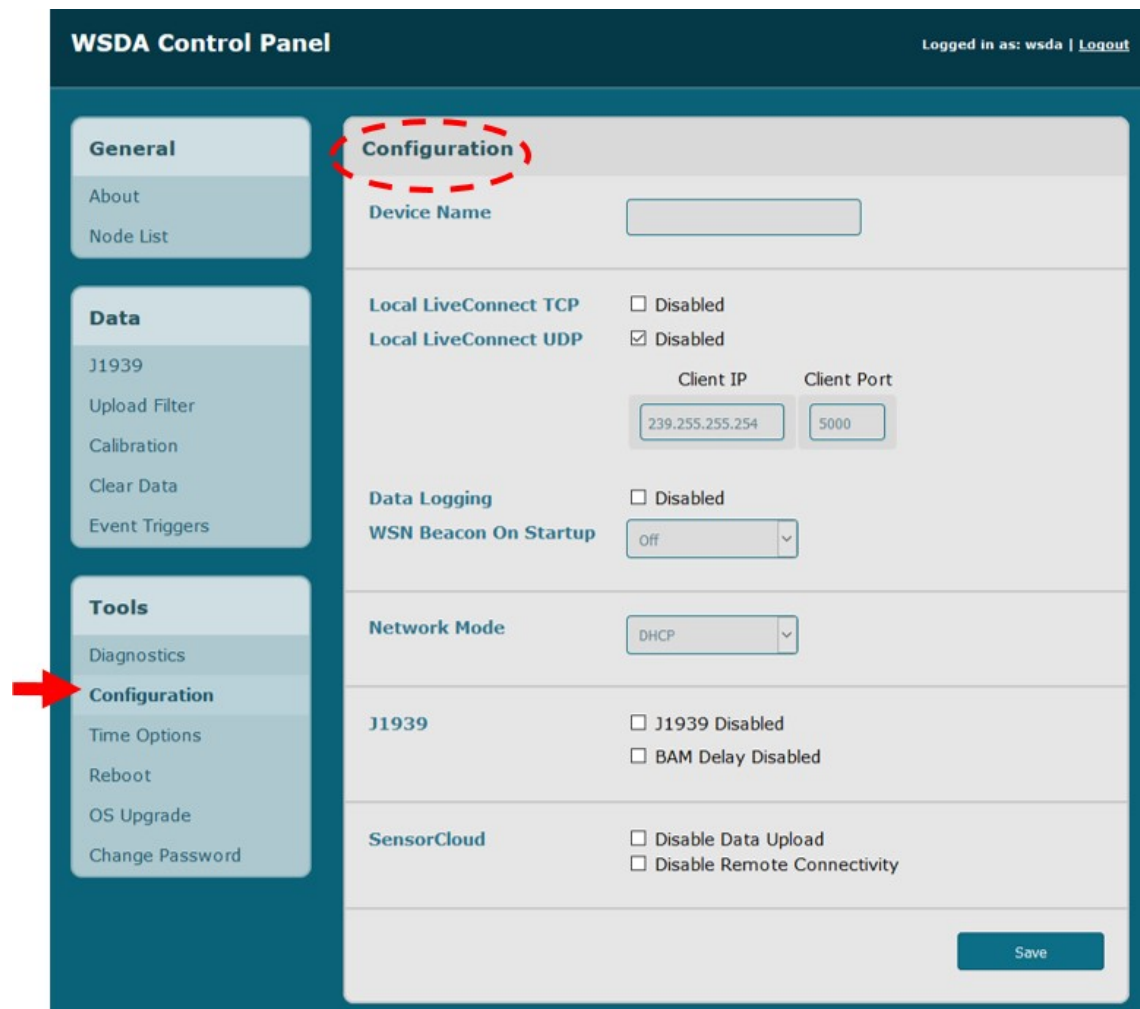

Figure 21 - Configuration Menu

**Device Name:** The device name is an alias given to the WSDA-2000, so it is more easily recognized. By default, the device name is not assigned. To enter a name, type it into the field and click the Save button.

**Local Live Connect:** The Local Live Connect setting allows users to disable Live Connect on the local network. This is important if data security is a concern. Disabling Live Connect prevents other

users on the network from accessing the data stream . If Live Connect is disabled it will not be available for connecting to SensorConnect unless done remotely through SensorCloud™ ( [see Remote Connectivity on page 44](#)). The default is for Live Connect to be enabled.

**Data Logging:** Data logging saves acquired data to the gateway internal memory, and also makes it available to the CAN J1939 Bus, SensorCloud™, and a host computer through Live Connect. Disabling data logging will prevent data only from being stored in the gateway internal memory and from being uploaded to SensorCloud™. The data will still be available to SensorConnect through Live Connect and for the CAN J1939 bus. The default setting is that all data logging is enabled. When data logging is enabled the gateway waits for time synchronization ( [see Time Options on page 39](#)), sets the node synchronization beacon, sets the gateway wireless node communication frequency, and then begins logging data.

**WSN Beacon On Startup:**The beacon is used to precisely coordinate node data acquisition and data transmission in the wireless sensor network (WSN) during synchronized sampling.

**Network Mode:** The network mode determines whether the gateway has a dynamic or a static IP address, which is used to identify it on the network. A dynamic, or DHCP network, automatically assigns the gateway an IP address. The static IP setting allows manual assignment of the IP address. A static IP address is required if the network does not have a DHCP server or if the gateway will be connected directly to a host computer and not used on a network. The default setting is for a DHCP network.

If Static IP is selected, additional menu settings will appear ( [Figure 22 - Static IP Settings](#)). The **Static IP Address** is the IP Address to which the gateway will be assigned. This cannot be the network address or the broadcast address of the subnet. The **Static Subnet Mask** defines the range that the gateway can communicate (on the subnet). For example, if the gateway IP Address is 192.168.0.100, and the subnet mask is 255.255.255.0 the gateway can communicate with all addresses between 192.168.0.0 and 192.168.0.255. The **Static Gateway** option allows users to define an address the gateway can communicate with outside of its subnet. This requires the gateway to be able to access the internet on a static network.

Network Mode	Static IP
Static IP Address	192.168.0.100
Static Subnet Mask	255.255.255.0
Static Gateway	

Figure 22 - Static IP Settings

To setup the host computer for direct communications with the gateway, the host computer IP address must be changed so that it has the same subnet as the gateway. The gateway subnet in the example above is the first three sets of numbers in the IP address (192.168.0). The last set of numbers (100 in the example) will be the unique identifier for each device on the network (the gateway, computer, and other devices will each have a different number).

To change the IP address on a computer with a Window operating system, try the following steps:

1. Find the active Local Area Connection. Go to the Control Panel, and click on the Network Connections folder.
2. Right-click on the active Local Area Connection, and select properties.
3. Scroll down, and double-click on Internet Protocol (TCP/IP).
4. In the window select Use the Following IP Address.
5. Enter the subnet into the field entitled IP Address, and add a fourth number. It can be any number between 0 and 255, except the number that the gateway or any other device on the network is using.
6. In the Subnet Mask field, enter 255.255.255.0.
7. Save and exit the menus. Setup is complete.

**J1939:** The J1939 CAN output allows sensor data to be pushed out to a user-designed J1939 CAN bus through the WSDA-2000 multi-port connector. For more information [see CAN J1939 Output on page 22](#). The default setting is for the J1939 output to be enabled.

**BAM Delay Disabled:** The J1939 standard is based off of the CAN standard which defines CAN packets that can transmit a maximum payload of 8 bytes. J1939 is able to send larger payloads by sending the data using multiple CAN packets. For large J1939 broadcast packets (greater than 8 byte payloads), the standard requires there be a 50 ms delay between each successive CAN packet. This delay may be disable by checking the BAM Delay Disabled box.

**SensorCloud:** The SensorCloud™ feature allows enabling and disabling of the transmission of sensor data from the gateway internal memory to the web-based SensorCloud™ database. It also allows remote access to the gateway Control Panel through Live Connect ( [see Remote Connectivity on page 44](#) ). When enabled the gateway will upload newly received data to SensorCloud™ at two minute intervals. In other words, it will transmit new data, wait two minutes, and then transmit any additional new data. The overall transmission time varies with sampling settings, quantity of data, and internet connection speeds.

### 4.3.3 Time Options

The Time Options menu allows configuration options related to how the gateway retrieves and uses time. The WSDA-2000 has two on-board clocks: the System Clock and the Real Time Clock (RTC). The purpose of the System Clock is to provide the operating system with a time source. The purpose of the Real Time Clock is to provide time updates to the System Clock and to provide a reference for the node synchronization beaconding function.

During normal operation, the WSDA-2000 synchronizes time from enabled time sources starting with the most accurate. On boot-up, the WSDA-2000 will try to get a new time. If it is unable to, it will check to see if it already has a non-expired time from the first source. If not it will move on to the next source. During boot-up the WSDA-2000 must successfully synchronize time before it can begin data acquisition. Once synchronization has occurred, the WSDA-2000 will continue to query the time source every hour, however synchronization is not required to continue data acquisition. Manually setting time on the WSDA-2000 will immediately override any synchronization attempts and allow data acquisition to start.

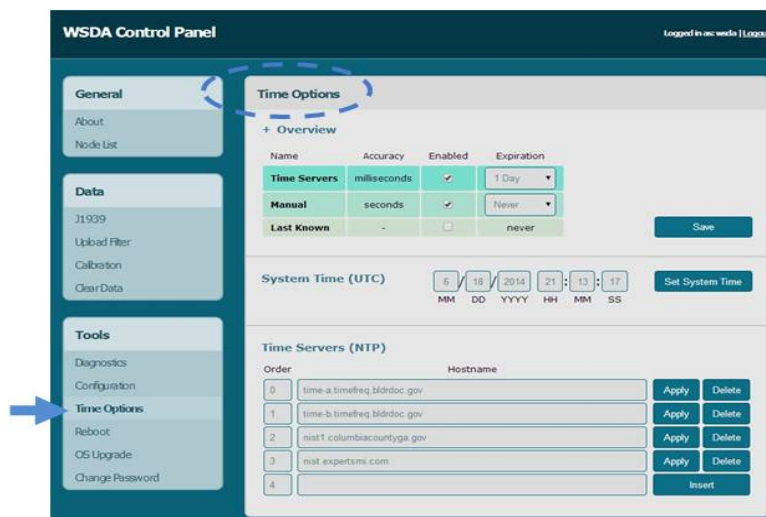

Figure 23 - Time Options Menu

The WSDA-2000 can synchronize its system time from four different **time sources**: Network Time Protocol (NTP) time servers, manual user entry, the last known time reference, or from an attached device with GPS.

- **Time servers** allows the WSDA-2000 to synchronize with external servers that provide the NTP service. A list of time servers is provided and can be modified by the user. This option requires connection to a NTP server and is the most accurate time source (with the exception of GPS).

- **Manual time** synchronization utilizes a time entered by the user. Enter the time in the System Time field, and select the Set System Time button.
- **Last Known** synchronizes to the last time recorded on the WSDA-2000. This could be from the internal Real Time Clock (RTC) or a file on the gateway.
- **GPS** allows the WSDA-2000 to synchronize with a compatible external GPS device for extremely accurate time.

#### NOTE

Using GPS as a time source is only available in the Time Options menu when a GPS integrated device, such as a LORD Sensing GPS enabled inertial sensor, is connected to the WSDA-2000 customization serial port. For more information refer to [see Recommended Sensors on page 1](#) or contact LORD Sensing Technical Support ([see Technical Support on page 78](#)).

To select the time source check the Enabled check-box next to the source name in the Time Sources menu. Each time source also has an accuracy field and an expiration field. Accuracy is fixed and dependent on the source. Expiration represents how long the time synchronization is valid for, and it is set by the user.

**System Time** displays the current time being used by the gateway. Time can be manually entered by typing directly into the field and selecting the Set System Time button. This function is normally used when no other time source (Time Servers, GPS, etc.) is available. If the time is set forward more than an hour from the host computer, the Control Panel web session will be expired and the user will have to log in again.

The **Time Servers** selections allows the user to set which time servers the gateway uses to synchronize time, and in what order it attempts to do so. The time servers are displayed in a list with the first server, order 0, being the first server checked. The time server must support NTP for the gateway to use it. The WSDA-2000 comes pre-configured with some known time servers.

To insert a new time server, fill in the last line Order column with the numerical order to place the time server in the list. Next enter the host name of the time server in the Hostname column. Click the Insert button.

To delete a time server locate the time server in the list, and click the Delete button next to it.

To change the order of an existing time server locate the time server on the list, and enter the new order number in the Order column. Click Apply. Other servers with the same numerical designation will automatically be moved.



#### 4.3.4 Reboot

The Reboot option allows the user to restart and reinitialize the gateway without cycling power.

To reboot the WSDA-2000, select the Reboot button. A three stage boot-up sequence will start, as described in [Table 11 - Reboot Indicators](#). The boot-up process will take between two and three minutes. Once booted, log in into the Control Panel as normal.

Stage	Indicator Behavior		
	CLOUD	WSDA	POWER
Initial Power On	ON red	ON red	ON green
Booting Up	ON red	flashing blue	ON green
Fully Booted	ON green and/or flashing blue	ON green	ON green

**Table 11 - Reboot Indicators**

### 4.3.5 Operating System (OS) Upgrade

Periodically, new versions of the WSDA-2000 operating system will be released to add features or make other updates to the system. On the recommendation of LORD Sensing Technical Support, gateways can be upgraded to the latest available operating system to take advantage of these new features or to correct operating issues. Updates may be found on the LORD Sensing website ([see Technical Support on page 78](#)).

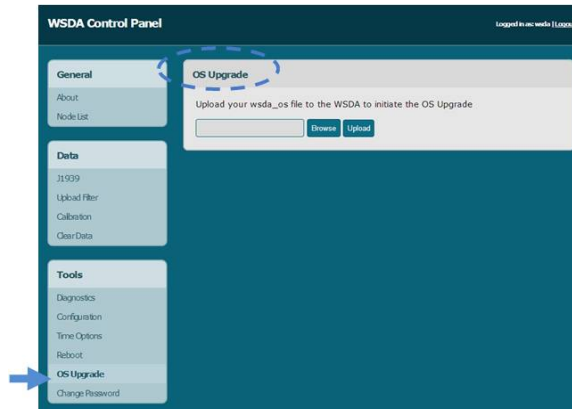

Figure 24 - OS Upgrade Menu

1. Download the upgrade file from the LORD Sensing website or LORD Sensing Technical Support.
2. As needed, extract the contents of the zip file into a folder on the computer. Verify there is a file with a .wsda\_os extension.
3. Select the OS Upgrade button in the gateway Control Panel.
4. Select the Browse button, and navigate to the folder containing the update file provided (example: firmware\_v2.3.3.wsda\_os).
5. Select the Open button, and then Upload. There are two parts to the upgrade: the upload and the actual upgrade. Once the upload reaches 100%, the status bar will reset and begin the upgrade process status. The entire upgrade can take fifteen to twenty minutes.

### 4.3.6 Change Password

The Change Password feature is used to change the username and the password required at log-in to the WSDA-2000 Control Panel.

The default username and password are:

- a. Login: wsda
- b. Password: wsda

Enter the current username and password and then the new password twice and select Submit.

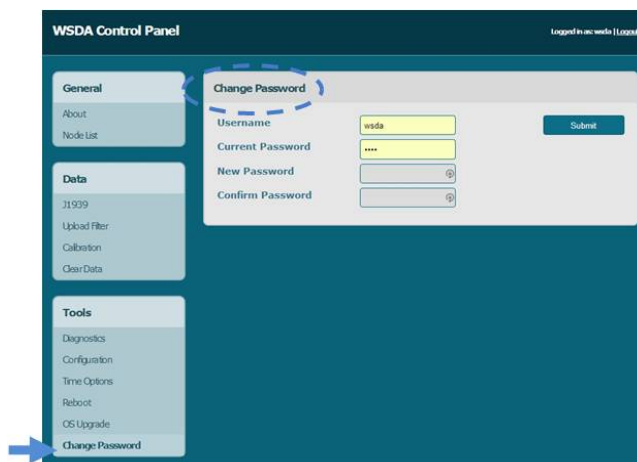

The screenshot displays the WSDA Control Panel interface. On the left, a navigation menu is visible with sections for General, Data, and Tools. The 'Change Password' option is highlighted in the Tools section with a blue arrow. The main content area shows the 'Change Password' form, which includes fields for Username (containing 'wsda'), Current Password (masked with dots), New Password, and Confirm Password. A 'Submit' button is located to the right of the form. A dashed blue circle highlights the 'Change Password' title and the Username field.

Figure 25 - Change Password Menu

## 5. Remote Connectivity

Some SensorCloud™ data plans allow remote access to the WSDA-2000 through the SensorCloud™ web interface. This allows access to the gateway Control Panel (including data downloading) and to Live Connect and SensorConnect for remote configuration of gateways and nodes. Data downloading from the gateway memory is also available in this way. Access is obtained through a secure web interface, although local installations of Live Connect and SensorConnect are required on the host computer to access the nodes.

To begin, log in to SensorCloud™ (*see Data Access on page 1*).

### Access the Control Panel Remotely

1. While in SensorCloud™ open the Devices menu, and select the device Configuration link (*Figure 26 - Gateway Configuration*).

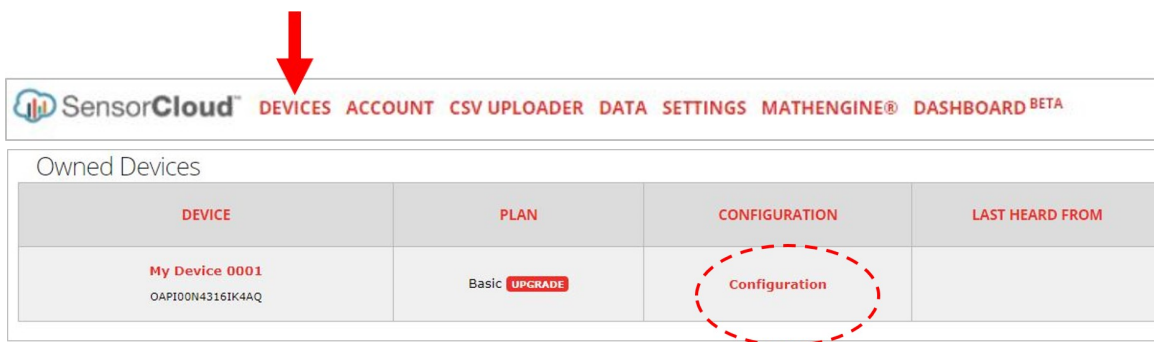

Figure 26 - Gateway Configuration

2. Select the Control Panel button (*5. Remote Connectivity*). If it is not present, the SensorCloud™ account does not include the feature and must be upgraded.
3. Log in to the Control Panel when prompted. All Control Panel features are now available (*see Gateway Menu Navigation on page 18*).

## Download Data Remotely

1. Download the WSDA Data Downloader from the WSDA-2000 product page at: <http://www.microstrain.com/wireless/WSDA-1500> >Downloads > Software.
2. Connect to the gateway Control Panel as described above.
3. Copy the URL from the browser address bar when in Control Panel (*Figure 27 - Control Panel URL*).
4. Open the WSDA Data Downloader program and paste the address into the WSDA URL field.
5. Enter the log-in credentials for Control Panel, and select Connect to WSDA.
6. Enter SensorCloud™ credentials when prompted, and use WSDA Data Downloader as normal (*see on page 1*).



Figure 27 - Control Panel URL

## Access Live Connect Remotely

1. In the device configuration menu, select the Live Connect button (*5. Remote Connectivity*). If the button is not present, the SensorCloud™ account does not include the feature and must be upgraded.
2. When the button is selected a file download (info.live\_connect) will begin. Open the file when the download is complete, and Live Connect will open automatically. The device will appear in the Live Connect window under User Defined WSDA's (*Figure 28 - Remote Live Connect Connection*).
3. Use Live Connect to connect to the gateway control panel (*see Gateway Settings on page 14*) or to SensorConnect (*see Connecting to Nodes and on page 1*) as normal.

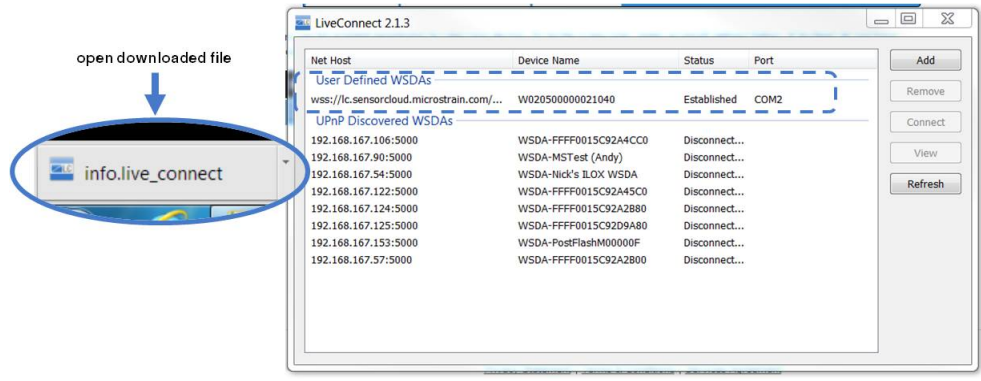

Figure 28 - Remote Live Connect Connection

## 6. Using the Beacon

In synchronized sampling, the beacon feature is used to coordinate sampling and transmission timing between multiple nodes. The primary purpose is to avoid data collision, guarantee timing between samples from different nodes, and to time-stamp the data. The beacon cannot be used in any another sampling mode.

To acquire tightly synchronized, absolute wireless network times, enable the beacon from the WSN Beacon On Startup setting in the gateway control panel ([see Configuration on page 36](#).) When the beacon is enabled, the gateway broadcasts a data message once every second containing a Coordinated Universal Time (UTC) time stamp, and it is used to update each node's real time clock (RTC). This continuous synchronization beacon, coupled with the accuracy of the gateway and node clocks (+/- 3 ppm drift), provides a node-to-node synchronization within  $\pm 50$  microseconds. The gateway receives the UTC from the host computer, so the host must be connected to a UTC time server to achieve that accuracy. There is some lag inherent in the Microsoft Windows distribution of the UTC. This dictates the overall accuracy of the time-stamp, but the synchronization times between the gateway and nodes will be consistent because of the accuracy of the embedded RTC clocks.

Nodes must be on the same transmission frequency (channel) as the gateway to receive the beacon broadcast command. When the beacon is active, the gateway device status indicator will pulse blue once per second. When the nodes connected to the gateway are in synchronized sampling mode, the network can be put to sleep by turning off the beacon and then resuming transmitting once the beacon is enabled. Any node that is actively sampling in synchronized sampling mode on the same frequency as the gateway will synchronize to it automatically if the beacon is activated.

To avoid interference with other devices it is recommended that the beacon be disabled when not in use. Do not operate multiple gateways on the same frequency.

To enable and disable the beacon in SensorConnect™, select On or Off from the Toggle Beacon tile. A green pop up window will appear confirming the successful action. Note: When starting a synchronized network using SensorConnect™, it automatically starts the beacon using the host computer's time, not the gateway's time, which may negatively impact the quality of the synchronized data.

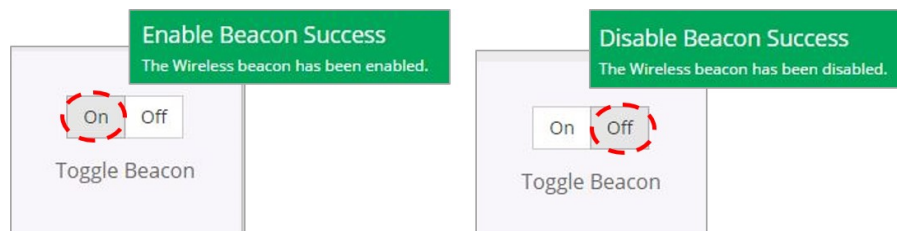

Figure 29 - Synchronized Sampling Beacon

## 6.1 System Bandwidth in Synchronized Sampling

When using synchronized sampling all nodes in the wireless network are queried and given time slots of various lengths based on their configuration (# of channels, sample rate, etc.). Nodes will only transmit data during these time slots, therefore eliminating over-the-air data collisions. The total time available for node transmissions is defined by the system bandwidth. Because the system bandwidth is finite, only a fixed number of nodes can be supported when using synchronized sampling. The number of nodes is largely dependent on node configuration, as each consumes part of the bandwidth. Use the online network bandwidth calculator to determine the bandwidth capacity for a particular system configuration: <http://www.microstrain.com/configure-your-system>

## 6.2 Synchronized Sampling with Multiple Gateways

If there are multiple gateways in the system, a Global Positioning System (GPS) time source can be used to synchronize time between the gateways. Only gateways with attached GPS devices, such as a LORD Sensing GPS or GNSS-enabled inertial sensor, will have this option ( *see Recommended Sensors on page 1*). The gateway-to-gateway synchronization for systems using the GPS time source is on the order of micro-seconds.

Another option available on the WSDA-1500 gateway is to use an NTP time reference from the internet. As there is lag inherent to using the internet to get a NTP time, it is not recommended for synchronizing multiple gateways. This option would have a gateway-to-gateway synchronization on the order of 10's of milliseconds. A good compromise would be to use of a local NTP time reference. This would reduce the gateway-to-gateway lag to milliseconds. For information on how to adjust the times settings *see Time Options on page 39*.



## 7. Sensor Node Access

### 7.1 Connect to Nodes

Several methods can be used in SensorConnect to establish communication with the nodes: the automatic node discovery on the same frequency, automatic node discovery on a different frequency, and add node manually.

#### 7.1.1 Automatic Node Discovery on Same Frequency

If the base and node are on the same operating frequency, the node will populate below the Base Station listing when powering on the WSDA-2000.



Figure 30 - Node Discovered On Same Frequency

#### 7.1.2 Automatic Node Discovery on Different Frequency

If a red circle with a number appears next to the Base Station, the node may be operating on a separate radio channel. Select the Base Station and then select the Nodes on Other Frequencies tile.

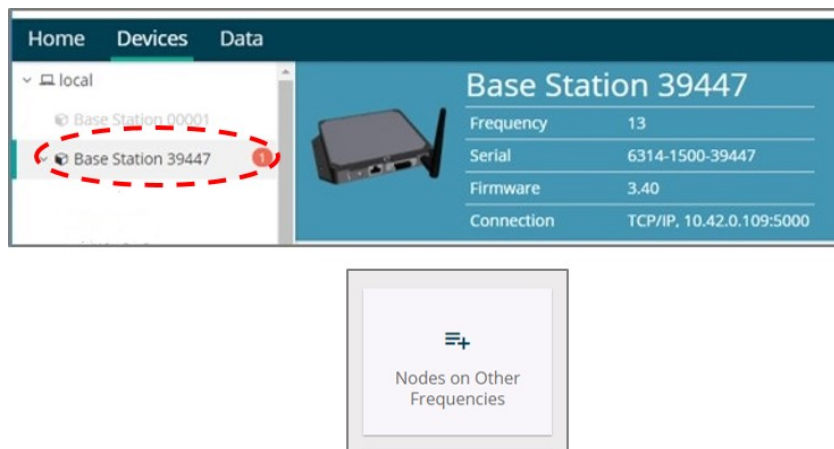

Figure 31 - Node On Other Frequency

Highlight the new node being added and select Move Node to Frequency (#).

Select a Node to move to this BaseStation's frequency.

Node	Frequency	Last Heard
61506	13	6 minutes ago
62884	11	8 minutes ago

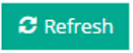

 

Figure 32 - Move Node

### 7.1.3 Manually Add Node

Adding a node manually requires entering the node address and its current frequency setting.

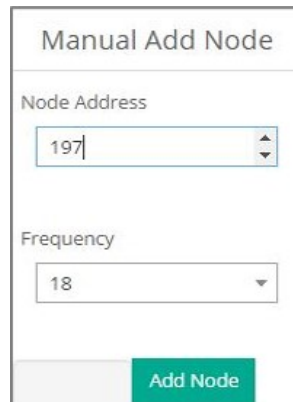

Figure 33 - Add Node By Address

If the node was successfully added, two confirmation messages will appear and it will be listed under the Base Station.

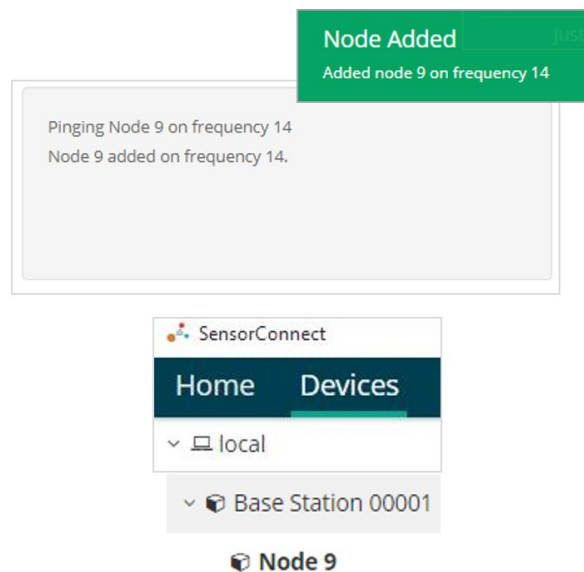

Figure 34 - Add Node Confirmation

If the node failed to be added, a failure message will appear. This means the node did not respond to the base station which could indicate the node is not in idle mode or it may be on another frequency. If "Add Node Anyway" is selected, it will associate that node with the channel entered but it is likely there will be a communication error. If the node was not in idle, move the base station to the frequency of the node and issue a "Set to Idle" command.

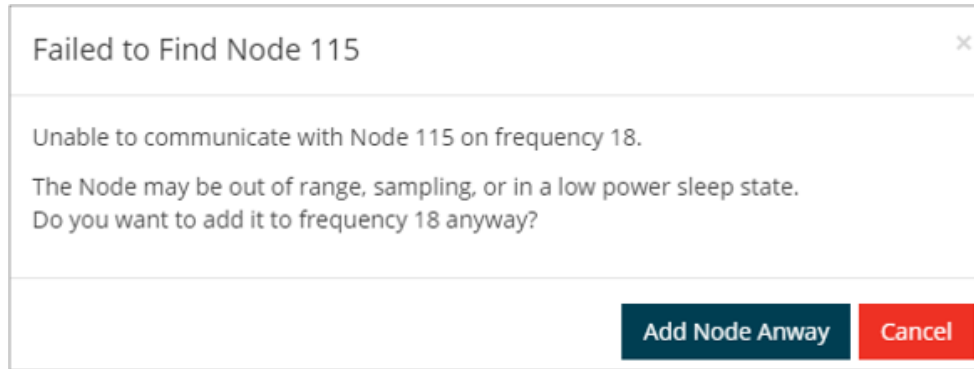
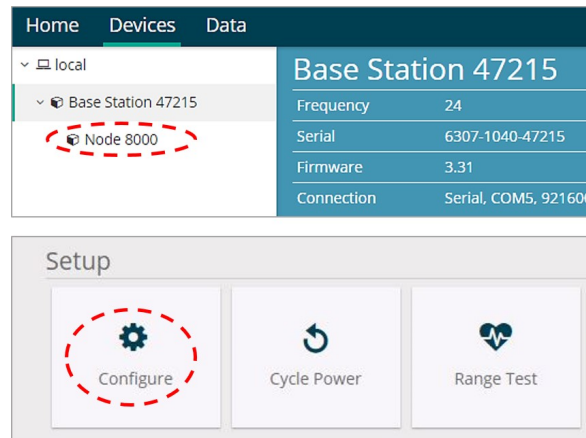

Figure 35 - Failure to Add Node

## 7.2 Configure Node

Node settings are stored to non-volatile memory and may be configured using SensorConnect. To access the node configuration menu, under Devices select the node and then the Configure tile.



The configuration menus show the channels and configuration options available for the type of node being used.

Wireless Node Configuration

Hardware
Calibration
Sampling
Power

Input Range

Channel(s)	Input Range
1 - Differential 1	±39 mV (Gain: 64) ▼

Hardware Offset

Channel(s)	Offset	Balance Target	
1 - Differential 1	640	Mid (50%) ▼	<span style="background-color: #27ae60; color: white; padding: 2px 5px;">Auto Balance</span>
<div style="background-color: #2980b9; color: white; padding: 2px 5px; display: inline-block;">Auto balance complete (achieved: 49.98%)</div>			

Anti-Aliasing Filter

Channel(s)	Filter Cutoff
1 - Differential 1	128 Hz ▼

### 7.3 Configure and Start Sampling

To start a sampling session, nodes can be selected individually by selecting the Node name and then the Sample tile.

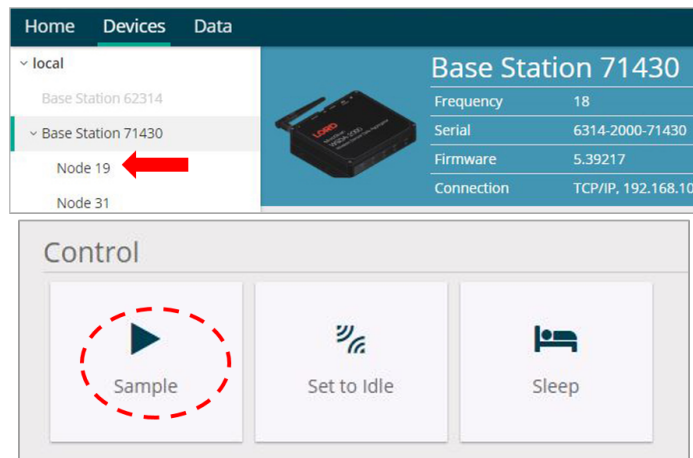

To sample multiple nodes as a group, select the Base Station and then the Sampling Network tile.

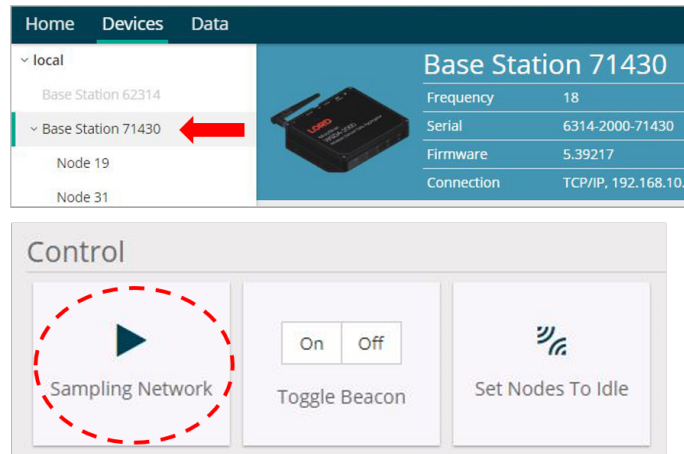

As a group, they will all be set to the same sampling mode. When the Base Station is selected, all the nodes will appear in a list with a check mark to the left, all of the nodes checked off will be included in the sampling. Uncheck the nodes to be excluded from the sampling.

**Figure 36 - Network and Node Configuration Menu**

- **Synchronized** - By selecting Synchronized, all nodes in the network will periodically synchronize their time clocks to a beacon that is broadcasted by the **WSDA gateway**. Each beacon contains a UTC timestamp, allowing nodes to timestamp their collected data within an accuracy of +/- 50 us.

Each node will also buffer data and transmit this data in time-slots allocated prior to sampling. Using time-slots assures the transmissions will not “collide”, or corrupt each other. It also provides a means for efficiently scaling the size of the network to allow as much data throughput as possible.

If Synchronized is deselected, the node will not require a beacon time source and will transmit a data transmission for each measurement sweep. The user should deselect Synchronized if, either low latency, or the lowest possible power at slow sample rates, is required.

- **Lossless** - The user can achieve near lossless data collection in most environments through the use of data buffering, radio acknowledgments, and retransmissions. Each node buffers collected data and timestamps to an internal 2 Mbit FIFO buffer. For each transmission, data is pulled from this buffer. Upon receiving the data packet, an acknowledgment is sent from the **WSDA gateway** providing the beacon. The node will retransmit data until this acknowledgment is received. Inherent overhead in the transmission scheduling protocol assures the node time to recover from periods of poor radio communication.

This feature allows lossless performance in environments where the node achieves as low as

50% packet error rate. It also allows for operation in situations where the gateway and node move in and out of range of each other.

**NOTE:** The Lossless feature is only available when Synchronized is enabled. Disable Lossless if the application requires consistent latency or can tolerate lost data.

- **Node:** Indicates the node address beside a box with a check mark. This box is checked by default to include the node in the sampling. Uncheck the box to exclude the node from the sampling.
- **Channels:** Provides a drop-down menu to select the desired sensor channels for the node.
- **Sampling:** Displays a drop-down menu to select the sample rate. "Continuously" samples indefinitely, "For" specifies a fixed sampling time-frame, and "Bursting" allows short sampling durations performed at periodic intervals.
- **Data Type:** Select the resolution of the data reported by the node. Selecting lower resolution data will require fewer transmissions and lower power. Selecting "Float" will request the node send data in the configured calibration unit type.
- **Log/Transmit:** Select "Log Only" to have the node store all collected data to flash memory for later download. Select "Transmit Only" to have the node transmit all data while it is collected. Or select "Log and Transmit" to have the node perform both operations.
- **% Total:** Indicates the percentage of total over-the-air bandwidth reserved for each node.
- **Status:** Displays network errors.
- **Apply and Start Network:** Applies all of the settings, starts the entire network, and starts the Base Station's beacon.
  - **Apply and Arm Nodes:** This setting allows the user to Arm all of the nodes without starting the beacon. If the gateway has already enabled the beacon, this setting will keep the gateway's beacon.
  - **Apply Only:** Saves the settings to memory and not start the network.

#### 4. Stop Sampling

To stop all (or selected) nodes on a network, select the Set Nodes to Idle tile and indicate with a check mark which nodes are to be set to idle mode. If the Broadcast option is enabled, a signal to all nodes (including unsolicited nodes) will be sent out to request they return to idle. The nodes must be moved to the same frequency as well.

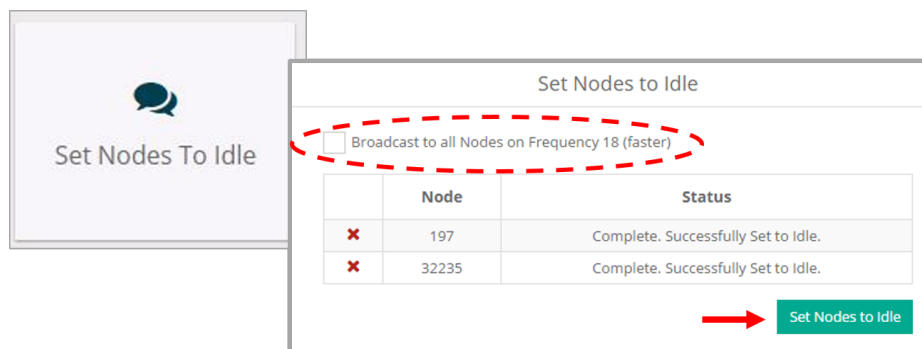

Figure 37 - Set to Idle



## 8. Viewing Data

### 8.1 SensorCloud

## 8. Data Handling

Data acquired through SensorConnect is automatically saved on the host computer. Saved data can be uploaded to SensorCloud. Ethernet gateways provide the option to automatically port the data to SensorCloud during data acquisition for near real-time display and aggregation. Ethernet gateways can also be configured to save data locally to internal memory for future upload to the host computer or SensorCloud.

SensorCloud is based on cloud computing technology and is designed for long term collecting and preservation of data. Features include time series and visualization graphing, automated alerts, and data interpretation tools such as data filtering, statistical analysis, and advanced algorithm development with the integrated MathEngine® interface. Leveraging the open source API, SensorCloud can also be used to collect data from other LORD Sensing sensor products or third-party systems. Basic SensorCloud services are available to all users free of charge at: <http://www.sensorcloud.com/>.

### 8.1.1 Navigating Menus

The SensorCloud interface has **six main views**. When logging in as a registered user, the Device view is the default. Navigate to other views by clicking the view name at the top of the page (*Figure 38 - SensorCloud Menu Views*). The Data and Settings views are only available once a device is selected from the device list.

The screenshot shows the SensorCloud interface with a navigation menu at the top. The menu items are: DEVICES, ACCOUNT, CSV UPLOADER, DATA, SETTINGS, and MATHENGINE®. A callout box points to the 'DEVICES' menu item with the text: "Device lists - select a device to access Data and Settings menus".

Below the menu, there are three sections of device lists:

- Owned Devices:** A table with columns: DEVICE, PLAN, CONFIGURATION, LAST HEARD FROM, DATA (JUN 18 - JUL 18) USAGE, and TOTAL STORAGE. It lists two devices: a "New Device" (OAP150228C4R769H) and a device with ID "W063140205021034".
- Shared Devices:** A table with columns: DEVICE, CONFIGURATION, and LAST HEARD FROM. It lists two devices: "MSTest (andy)" (FFFF015C91C7480) and "CallFrac - Heavy Loading Run Up 9-4-13" (OAP100C2599K4URZ).
- Demo Devices:** A table with columns: DEVICE and LAST HEARD FROM. It lists one device: "Demo Structure" (OAP1003972K5FD4X).

Figure 38 - SensorCloud Menu Views

**Device** - The device list shows every Ethernet gateway and API device associated with the SensorCloud account, including owned, shared, and demo devices. This view provides links to each device's SensorCloud subscription plan, configuration options, and a summary of last communications and data transactions.

**Account** - The account view is for logistic management of the SensorCloud account, such as changing the log-in password, accessing user email, and reviewing billing information.

**CSV Uploader** - The data upload feature enables data from any source (such as non-Ethernet LORD Sensing gateways, or third-party sensor) to be uploaded to the SensorCloud platform. The data must be in the LORD Sensing CSV format.

**Data** - This view is only available after a device is selected. It displays data that is collected from sensor nodes or uploaded from files. Data selections are listed by node channel or a user-defined label and can be enabled for display in the graph window. The interactive graph has navigational features such as panning, zooming, and an overview graph for single-click access to data points or ranges. There are also use and management features such as viewing the meta-data and downloading, embedding, and tagging data graphs.



Figure 39 - SensorCloud Data View

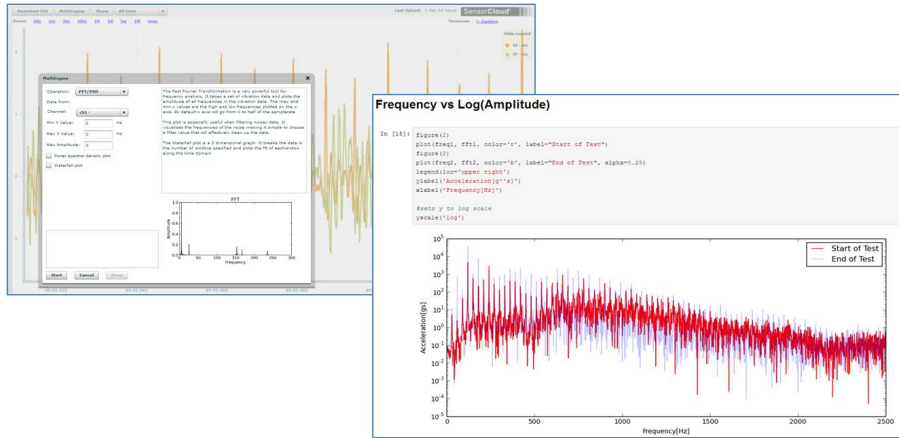

Figure 40 - MathEngine<sup>®</sup> View

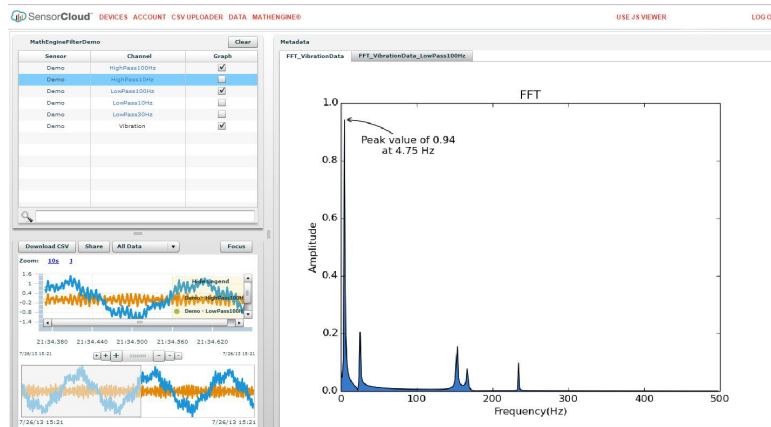

Figure 41 - FFT Graph in SensorCloud

## 8.2 SensorConnect

### 8.2.1 Using Dashboards and Widgets

Collected data is viewed on the Data page through the creation of dashboards and widgets. Think of dashboards as individual pages and widgets as an illustration on the page. Create multiple data widgets on each dashboard to display sampled data as a time-series graph, text chart, or a simple gauge that only displays the most current reading. This format provides an easy way to organize many sensors and networks, and it allows the information to be displayed in the most appropriate layout.

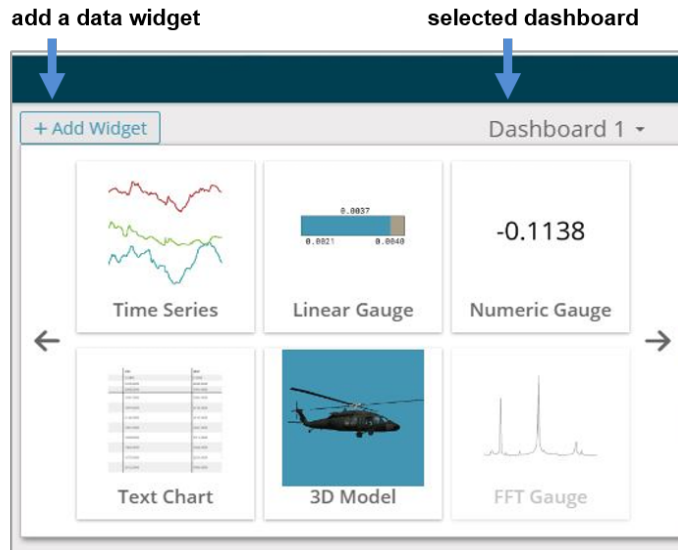

Figure 42 - Viewing Data

### 8.2.2 Navigating Graphs

Use the mouse along with the shift and control keys inside the graph window to adjust the data view.

Control	Action
Mouse wheel	Zoom in/out on x-axis
Shift + mouse wheel	Zoom in/out on y-axis
Mouse double-click	Zoom to extends
Shift + mouse left-click, drag left/right	Zoom window left/right
Shift + mouse left-click, drag up/down	Zoom window up/down
Ctrl + mouse left-click, drag	Zoom box

Table 12 - Graph View Controls

### 8.2.3 Widgets Options

The widget configuration menu is different for each type of widget but typically includes sensor or channel selections and widget settings such as titles and legends.

After adding a widget, left click to select and configure it in the Channels and Settings left sidebar menu. Under Channels, the channel(s) for the widget can be enabled and disabled.

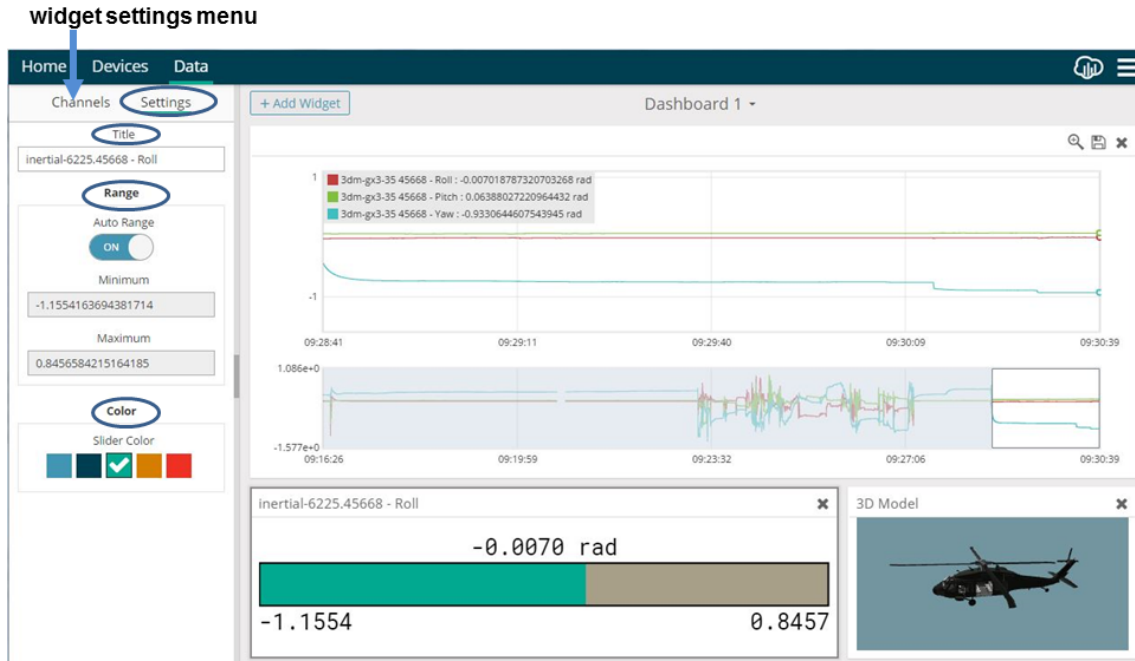

Figure 43 - Widget Settings Menu

### 8.2.4 Time Series Widget Menu

The Time Series Widget menu has two features to help optimize sensor data collection for export to a .csv file. *Snap to Latest* captures the most recent data and *Zoom* isolates specific events from a larger data sample ([see Exporting Data Files on page 63](#)).



Figure 44 - Time Series Widget Menu

## 8.2.5 Exporting Data Files

To export data to a .csv file, select the Export Data button on the Time Series widget > Export > name the document > save to the preferred location on the host computer.

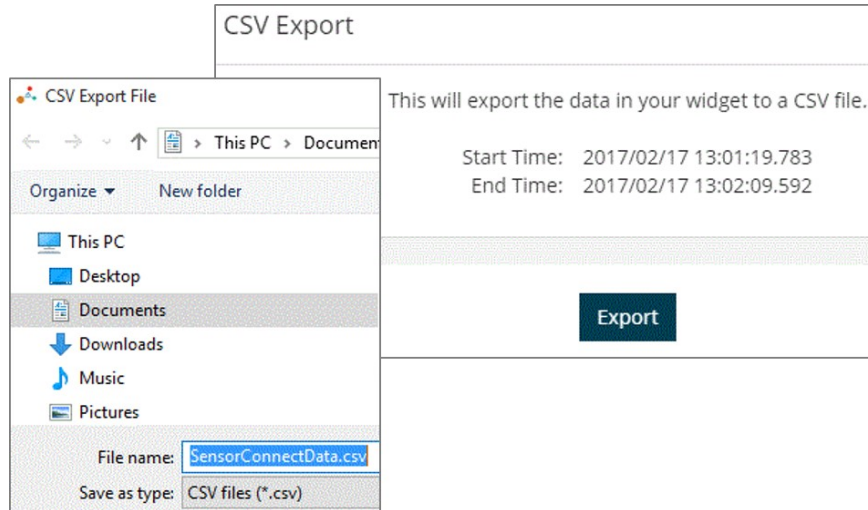

Figure 45 - Exporting Data

## 8.3 Using the Data Downloader

To view data using the Data Downloader, go to: <http://www.microstrain.com/wireless/gateways>, select the product > Downloads > WSDA Data Downloader, run the application, and open the window.

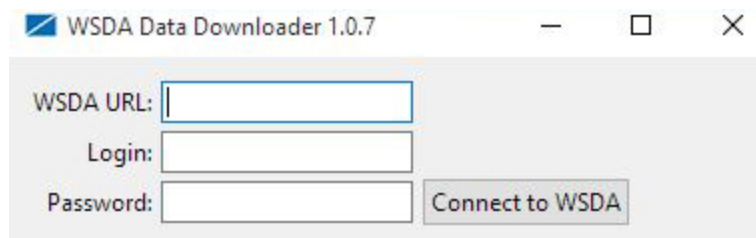

Figure 46 - Data Downloader Log-in Window

To find the WSDA URL, select the WSDA Control Panel tile from the Devices window in SensorConnect™.



Figure 47 - Access WSDA Control Panel

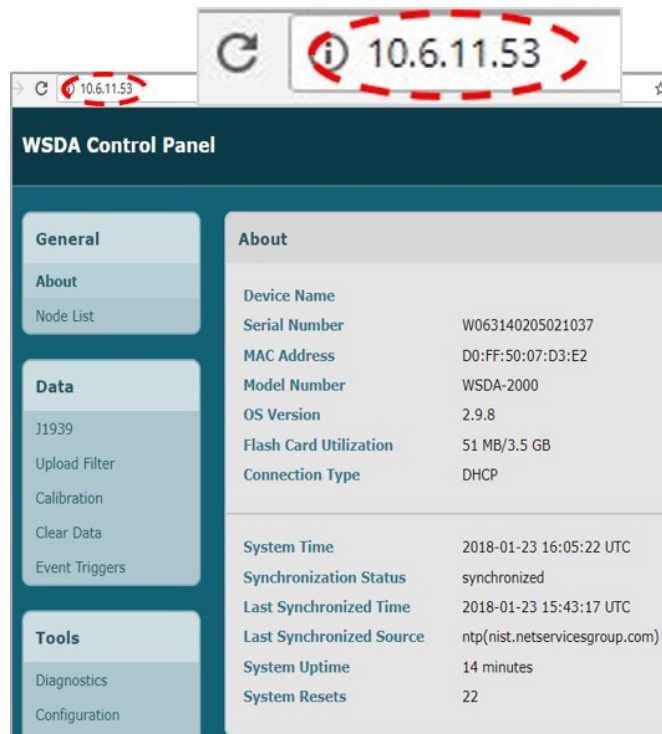

Figure 48 - WSDA URL

Copy and past the WSDA URL into the Data Downloader, enter WSDA Login and Password ([See Gateway Settings on page 14](#)), and select "Connect to WSDA".

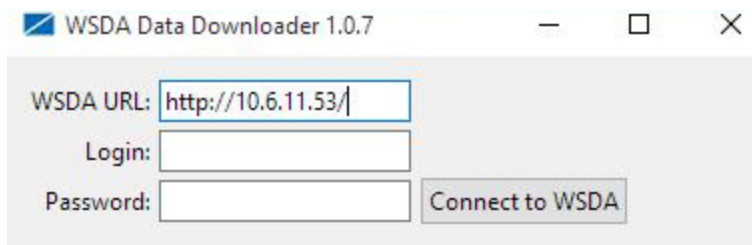

Figure 49 - Data Downloader Log in Window



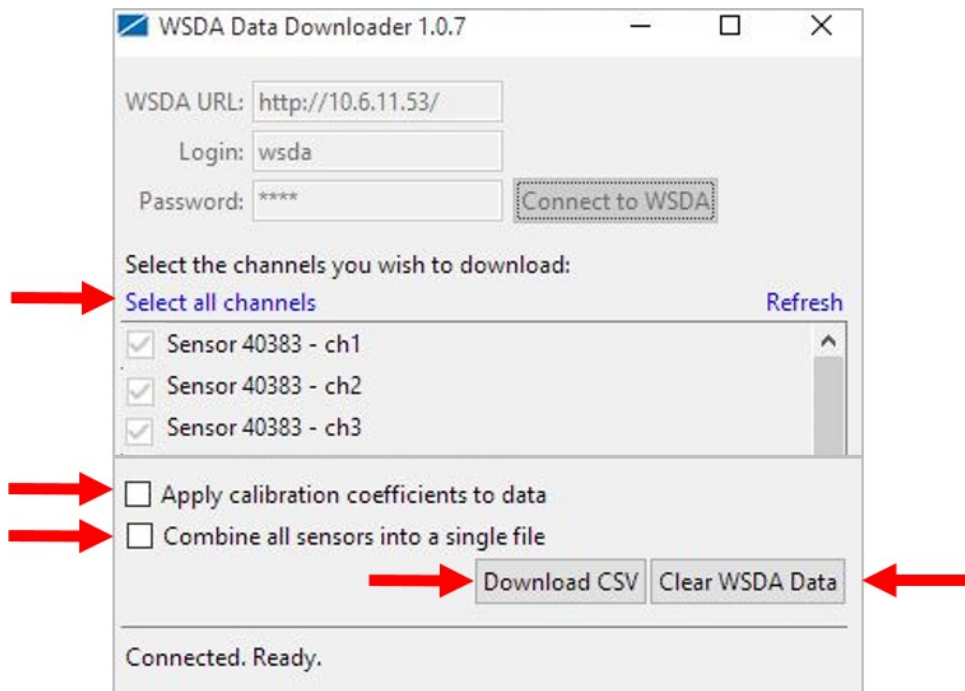

Figure 50 - Data Downloader Menu

The user may select to include all channels, or mark individual channels to include in the data download, apply the calibration coefficients ([See WSDA Data Downloader Calibration Coefficients on page 32](#)), and/or to combine all of the sensors into a single .csv file. "Clear WSDA Data" permanently deletes all data on the gateway.

Select "Download to CSV" and choose where to save the file on the host computer.

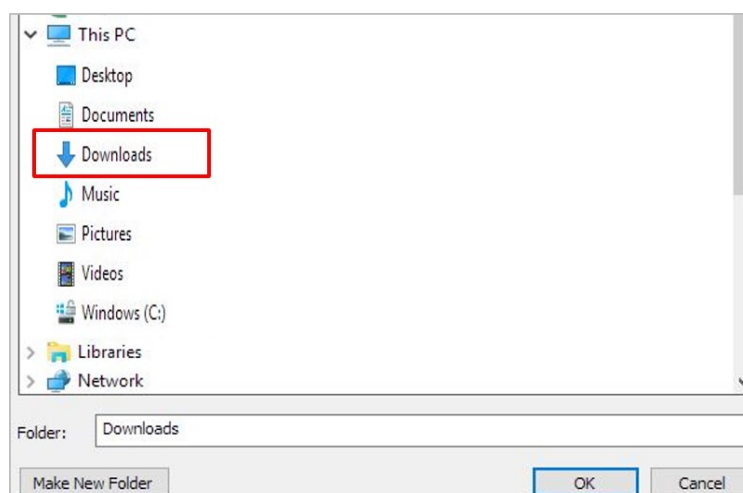
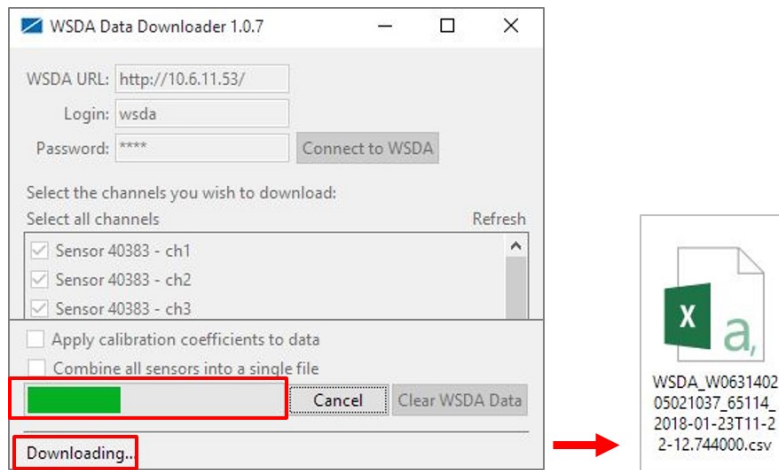

Figure 51 - Save CSV File to Host Computer

A green bar in the data downloader status window shows the progress and completion of the download process. The saved CSV file is named WSDA\_serial number\_node address\_timestamp by default.



**Figure 52 - Data Download Complete**

Upload the CSV file to SensorCloud™ to view the data. For SensorCloud™ log in instructions, see *SensorCloud* under [Viewing Data on page 57](#).

## 9. Gateway Installation

### 9.1 Installation Recommendations

The WSDA-2000 is rated for indoor use only, unless housed in a ruggedized outdoor enclosure.

The gateway has two mounting tabs with holes for fastening (*Figure 53 - Gateway Installation*). It can be mounted in any orientation, but it is recommended that it is mounted in a way that optimizes the wireless communications, typically with the antenna pointing upward. For more information *see NOTE on page 68*.

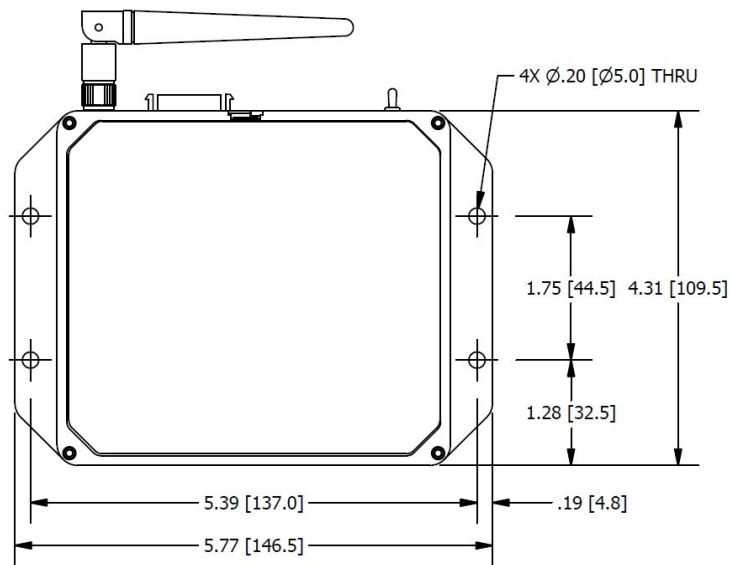

ALL DIMENSIONS ARE IN INCHES [mm]

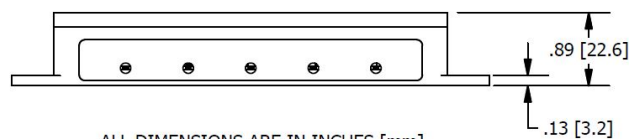

ALL DIMENSIONS ARE IN INCHES [mm]

Figure 53 - Gateway Installation

**NOTE**

In the event of communication difficulties, it may be necessary to disable WIFI on the host computer, or use a USB extender when collecting data.

The best method for ensuring optimal radio communication is to conduct an RF survey of the installation site. This is easily accomplished in SensorConnect by using the range test feature to quantify the radio signal strength (RSSI) in various scenarios. [See Range Test on page 69](#) for instructions on using SensorConnect for measuring RSSI. The following are general guidelines for maximizing communication range:

- **Line of Sight (LOS)** between the node and gateway. Try to avoid obstructions such as buildings, terrain, vegetation, or other physical barriers.
- **Increase the Mounting Height** of the node to allow a clearer LOS path to the gateway. Height above the ground is also important because reflections off of the ground can interfere at the receiver. Generally, the higher above the ground the better.
- **Minimize Radio Frequency Interference (RFI)** from other wireless devices, especially those operating in the same frequency range. This includes other nodes and 2.4 GHz WIFI routers. If other wireless devices are required nearby, mount them at different heights to minimize interference. Additionally, a different radio frequency may be selected using SensorConnect software.
- **Minimize Electromagnetic Interference (EMI)** such as that which is generated by power transmission equipment, microwaves, power supplies, and other electromagnetic sources.
- **Metal Objects** in close proximity to either antenna, particularly ferrous metals such as steel and iron, can be problematic for wireless communications. The larger the object, the greater the influence.

### 9.1.1 Range Test

After establishing communication between node and gateway, use the range test feature in SensorConnect to monitor the signal strength and to optimally position the nodes, gateway, and antennae for installation. Maximum achievable range is determined by the gateway and node power settings (found in the device Configure menu) and is highly dependent on the physical environment surrounding the devices.

1. Select the node name > Range Test

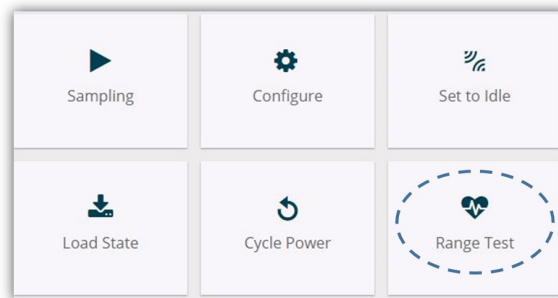

Figure 54 - Range Test Menu

2. RSSI is a measure of signal strength between the node and the base station. A higher RSSI value (closer to zero), will result in better node to base station communication. Reliable communication can be achieved with a signal strength greater than -75 dBm, in the absence of radio frequency interference. Position the node and gateway antennas where the best RSSI value is observed.

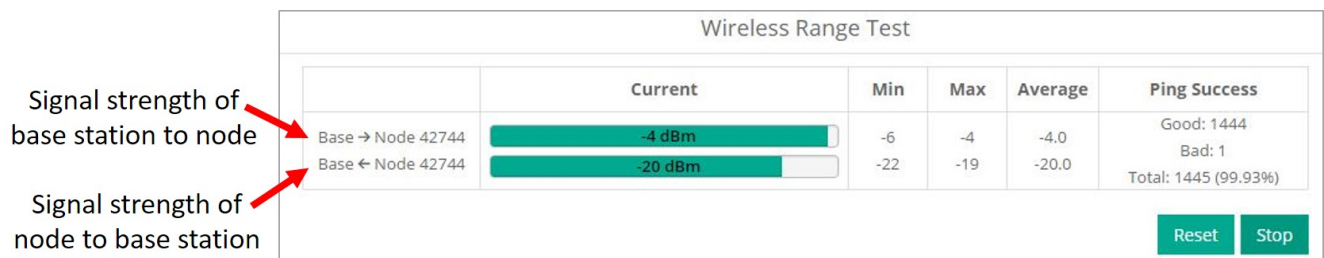
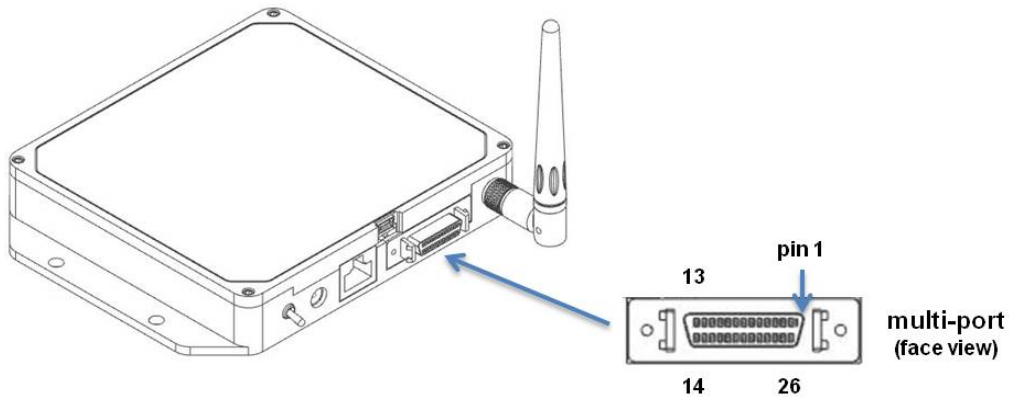

Figure 55 - Range Test Statistics

## 9.2 Multi-port Connector Interface

The WSDA-2000 multi-port connector is currently only used for CAN J1939 output connections and customized RS232 options, such as for use with LORD Sensing inertial sensors. The remaining are used during manufacturing, or are reserved for future use. For mating connector information and pre-made cable assemblies [See Gateway Accessories on page 71.](#)



Pin Number	Signal	Pin Number	Signal
1	(future use)	14	(future use)
2	(reserved)	15	+5V
3	+5V	16	(future use)
4	(reserved)	17	Tx
5	GND	18	+5V
6	(future use)	19	Rx
7	(future use)	20	GND
8	(not used)	21	1 PPS Out
9	(future use)	22	1 PPS In
10	GND	23	CAN High
11	(future use)	24	CAN Low
12	(future use)	25	(future use)
13	+5V	26	(future use)

Table 13 - Multi-port Pin Designations

### 9.3 Gateway Accessories

Description	LORD Sensing Part Number
Rugged outdoor enclosure with wired connector ports	call for information
Power supply for WSDA-2000	9011-0052
Standard whip antenna (FCC compliant)	9010-0170
Multi-port cable with flying leads	call for information
DB9 CAN Cable Assembly	6314-1510
Multi-port cable with inertial sensor connector (8 inch)	6302-2001
Multi-port cable with inertial sensor connector (36 inch)	6302-2002
Ethernet cable (10 feet long)	9022-0025

**Table 14 - Gateway Accessories**

## 10. Troubleshooting

### 10.1 Troubleshooting Guide

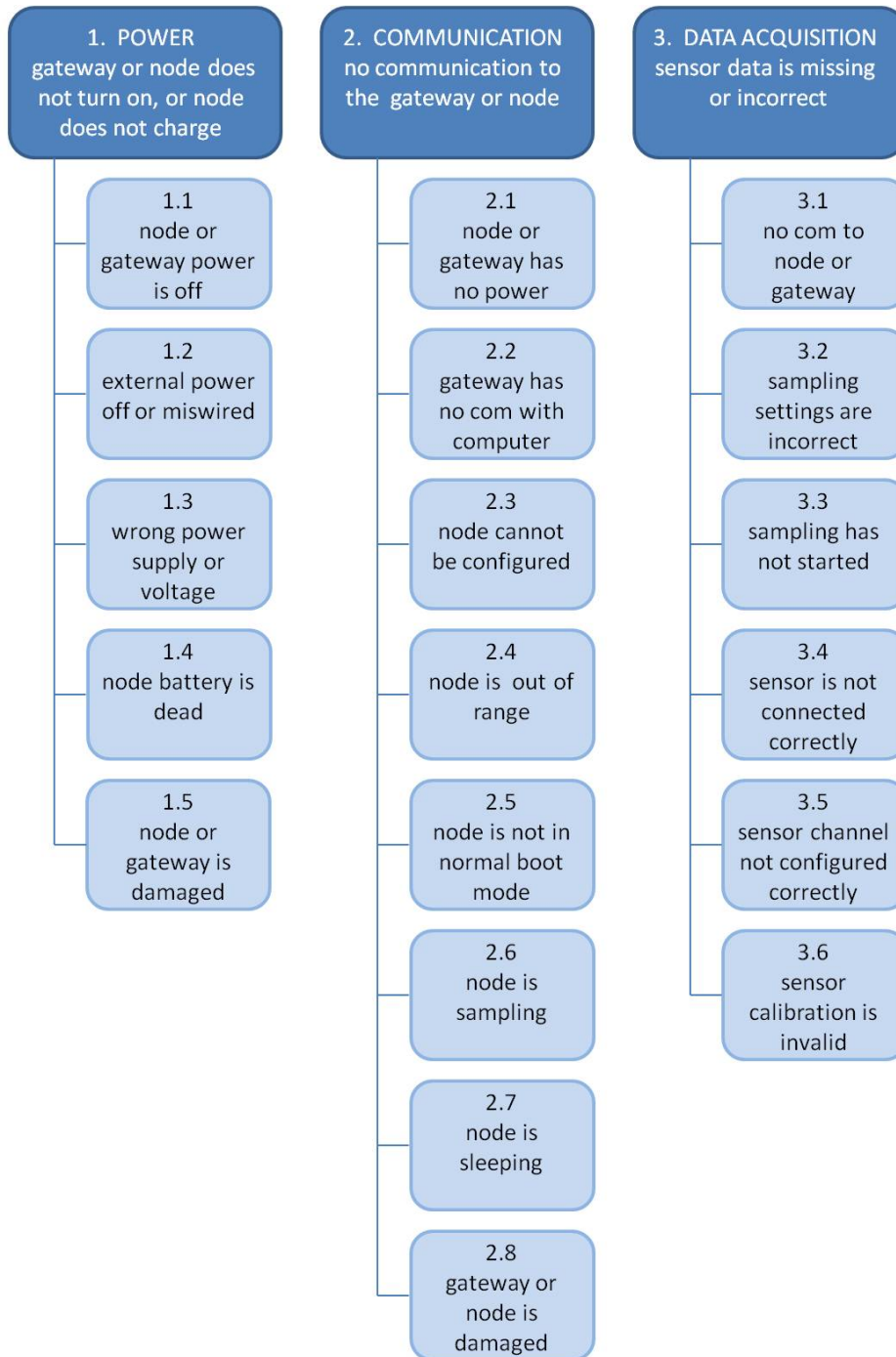



	Possible cause and recommended solution
<b>1. POWER</b> gateway or node does not turn on	<b>1.1 node or gateway power is off</b> The status indicator LED on the device may be off. Turn the device on, and the status indicator LED should illuminate.
	<b>1.2 external power is off or miswired</b> Verify the device power source is connected correctly and powered on.
	<b>1.3 wrong power supply or voltage</b> Using a power supply other than the one specified for the device (or an external supply that is outside of the device operating range) could result in permanent damage to the device or cause it to not work properly.
	<b>1.4 node battery is dead</b> If the node will not power on, the node battery may need to be replaced.
	<b>1.5 node or gateway is damaged</b> If all power settings and connections have been verified, and the node is still unresponsive, contact LORD Sensing Technical Support ( <a href="#">See Technical Support on page 78</a> ).
<b>2. COMMUNICATION</b> no communication to the gateway or node	<b>2.1 node or gateway has no power</b> Verify the node and gateway have power applied and that applicable power switches are on. Power is indicated on both devices by a status indicator LED.
	<b>2.2 gateway has no communication with the computer</b> Verify gateway communication in the software. Check, remove, and reconnect communications and power cables as applicable.
	<b>2.3 node cannot be configured</b> Observe the node status indicator LED to determine the device's state: boot, idle, sample, or sleep. If the node is sampling or sleeping, it cannot be configured. In SensorConnect, execute the Set to Idle command to put the node in idle state, allowing configuration to occur. If the user inactivity timeout is set very low, the configuration menu will have to be entered quickly, before the timeout occurs, putting the node back in a sample or sleep state.
	<b>2.4 node is out of range</b> Perform a bench test with the node in close proximity to the gateway to verify they are operational. For range test and installation recommendations. The system has been tested to operate with the node and gateway up to 2 km apart with clear line of sight.
	<b>2.5 node is not in normal boot mode</b>

	Possible cause and recommended solution
	<p>If the node status indicator shows the node booting in a mode other than the normal boot mode, it can be bypassed by cycling the node power rapidly three times, then leaving it on for normal power up. In normal boot mode the communication can be established with automatic node discovery (or manually) once the boot process is complete and the node is in idle state. Start-up mode can then be changed in the software.</p> <p><b>2.6 node is sampling</b> Observe the node status indicator LED to determine the device's state: boot, idle, active, or sleep. If the node is sampling, it cannot be configured. In SensorConnect, execute the Set to Idle command to put the node in idle state, allowing configuration to occur.</p> <p><b>2.7 node is sleeping</b> Observe the node status indicator LED to determine what state it is: boot, idle, active, or sleep. If the node is sleeping, it cannot be configured. In SensorConnect, execute the Set to Idle command to put the node in idle state, allowing configuration to occur.</p> <p><b>2.8 gateway or node is damaged</b> Verify all connections, power, and settings. If available, try installing alternate nodes and gateways one at a time to see if the faulty device can be identified. If no conclusion can be determined or to send a device in for repair, contact LORD Sensing Technical Support (<a href="#">See Technical Support on page 78</a>).</p>
<p><b>3. DATA ACQUISITION</b> <b>sensor data is missing or incorrect</b></p>	<p><b>3.1 no communication to node or gateway</b> Verify connections and power to the node and gateway. Verify they are powered on and communicating with the software. Enter a configuration menu to verify that the node can be accessed.</p> <p><b>3.2 sampling settings are incorrect</b> If the sampling mode, rate, or duration are not performing as expected, enter the node configuration menu, and verify the sampling settings.</p> <p><b>3.3 sampling has not started</b> If sampling is occurring, the sampling mode will be displayed next to the node name in SensorConnect. The node device status indicator will also be flashing the sampling mode code. If the node is not sampling, activate it in the software or with a sample on start up boot sequence.</p> <p><b>3.4 sensor is not connected correctly</b> Verify sensors connections and wiring. For non-standard connections contact LORD Sensing Technical Support (<a href="#">See Technical Support on page 78</a>).</p>

	Possible cause and recommended solution
	<p><b>3.5 sensor channel not configured correctly</b>                      Verify that the sensor is configured on the correct channel and has been enabled for data acquisition.</p>
	<p><b>3.6 sensor calibration is invalid</b>                      External sensors come with a factory calibration value that is entered during configuration. Internal sensors are factory calibrated and should not need adjustment. The calibration data is provided with the sensor when purchased.</p>

## 10.2 Communications Ports in Windows<sup>®</sup>

Serial gateways (including USB gateways) have either a standard serial or virtual communications port in Windows<sup>®</sup>. Windows<sup>®</sup> Device Manager can be used to determine what communication port the gateway is connected to.

1. Click on the Windows<sup>®</sup> Start icon, and select Control Panel.
2. Navigate to the System menu, and select Device Manager. The menus may appear different depending on the version of Windows and the View settings.

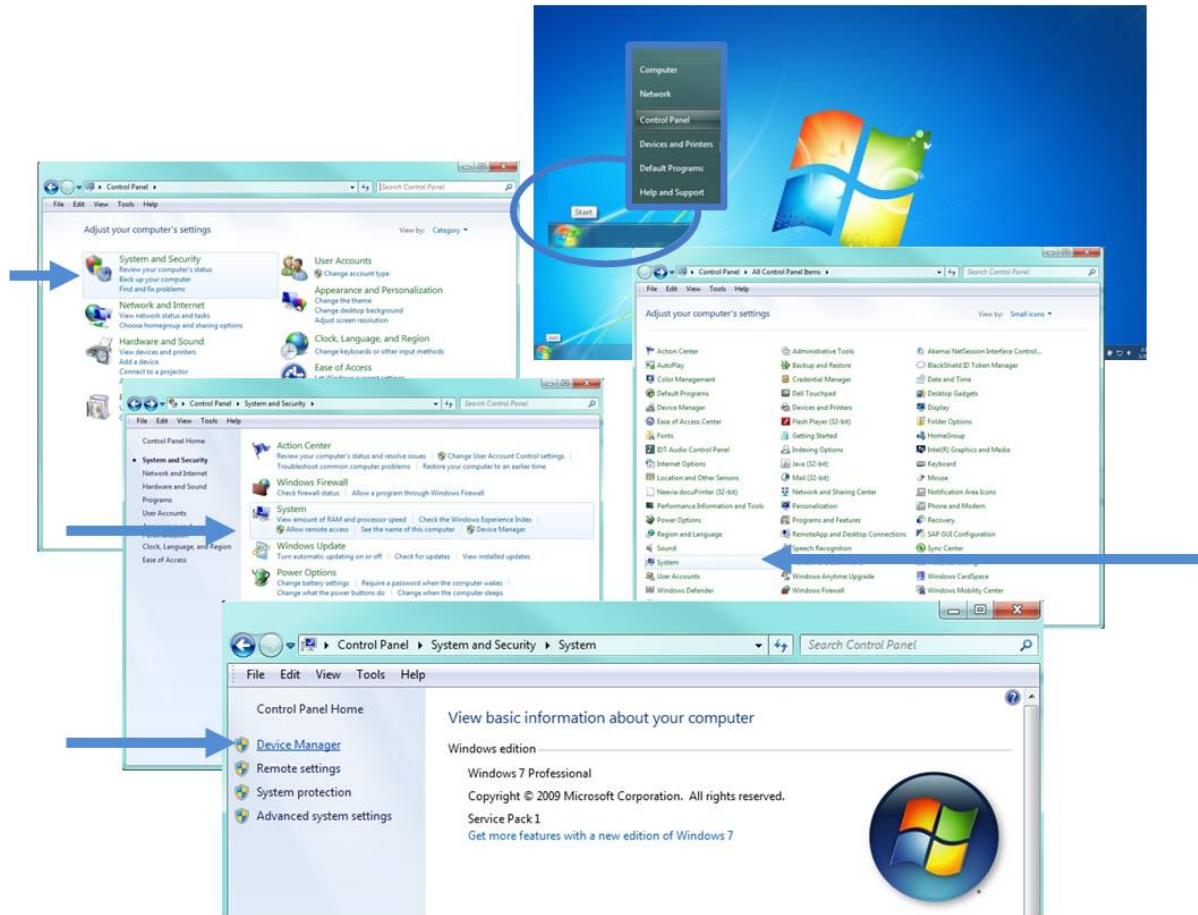

Figure 56 - Windows<sup>®</sup> System Menu

3. In Device Manager, expand the view for Ports (COM and LPT). Active COM ports will appear on this list with the COM port number. If no port is listed, the port is not recognized by the computer, and no gateway communication can be established.

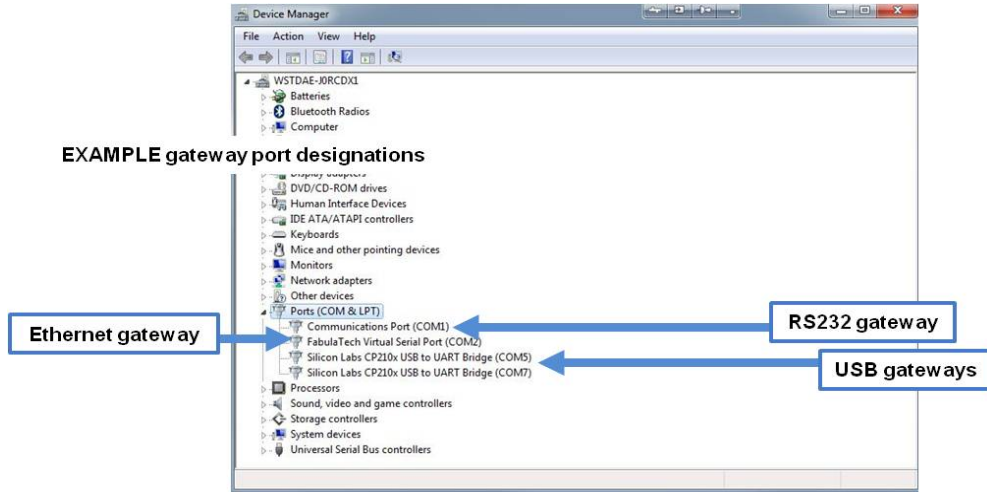

Figure 57 - Windows® Device Manger Menu

### Technical Support

There are many resources for product support found on the LORD Sensing website, including technical notes, FAQs, and product manuals.

<http://www.microstrain.com/support/documentation>

For further assistance our technical support engineers are available to help with technical and applications questions.

### Technical Support

[sensing\\_support@LORD.com](mailto:sensing_support@LORD.com)

**Phone:** 802-862-6629

**Fax:** 802-863-4093

9:00 AM to 5:00 PM (Eastern Time US & Canada)

**SKYPE:** microstrain.wireless.support

Live Chat is available from the website during business hours:

9:00 AM to 5:00 PM (Eastern Time US & Canada)

## 11. Wireless Equipment

### 11.1 Standard Models

For the most current standard, custom, and OEM product options, refer to the LORD Sensing website or contact the LORD Sensing Sales Department.

Model Number	Description	LORD Sensing Part Number
WSDA-2000	Wireless Sensor Data Aggregator	6314-2000

#### Configuration Options (specify at time of order)

- **LORD Sensing inertial sensor capable:** a different operating system is installed on the gateway to enable this feature, and to add GPS as an option in the time synchronization menu.

### 11.2 Wireless System Equipment

Model	Description	LORD Sensing Part Number
--	SensorConnect Software	8220-0023
--	SensorCloud Software Subscription (contact LORD Sensing Sales)	6600-0001
WSDA-2000	USB & Ethernet-based Gateway	6314-2000
WSDA-200-USB	USB Gateway	6307-2040
WSDA-BASE-101	Analog Output Gateway	6307-1010
WSDA-BASE-102	RS232 Serial Output Gateway	6307-1020
--	DB9 CAN cable assembly	3069-0045
--	Replacement USB cable	9022-0029
G-Link-200	Wireless Accelerometer Node	various models
G-Link-LXRS	Wireless Accelerometer Node	various models
SG-Link-LXRS	Wireless 2-Channel Analog Input Sensor Node	various models
SG-Link-OEM	Wireless 2-Channel Analog Input Sensor Node	various models
V-Link-200	Wireless 8 Channel Analog Input Sensor Node	various models
V-Link-LXRS	Wireless 7-Channel Analog Input Sensor Node	various models
TC-Link-LXRS	Wireless Thermocouple Node	various models
DVRT-Link-LXRS	Wireless Displacement Sensor Node	various models
IEPE-Link -LXRS	Wireless IEPE Accelerometer Node	various models

Table 15 - Wireless System Equipment

## Product Ordering

Products can be ordered directly from the LORD Sensing website by navigating to the product page and using the Buy feature.

<http://www.microstrain.com/wireless>

For further assistance, our sales team is available to help with product selection, ordering options, and questions.

## Sales Support

[sensing\\_sales@LORD.com](mailto:sensing_sales@LORD.com)

**Phone:** 802-862-6629

**Fax:** 802-863-4093

9:00 AM to 5:00 PM (Eastern Time US & Canada)



## 12. Specifications

### 12.1 Physical Specification

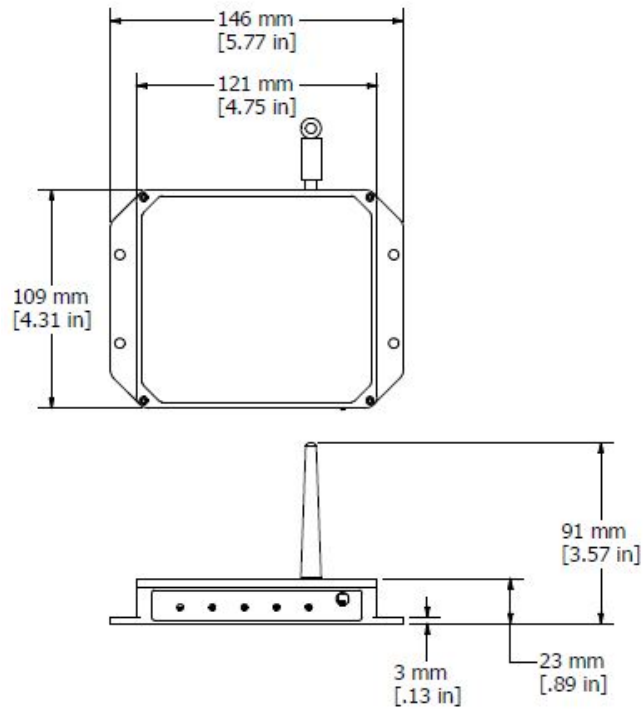

**Dimensions:** 147 mm x 110 mm x 23 mm without antenna  
**Weight:** 346 grams  
**Enclosure Environmental Rating:** General purpose indoor

## 12.2 Operating Specifications

Parameter	Specifications		
<b>General</b>			
Processor	ARM® Cortex™ A8, 1 GHz		
Operating system	Linux		
Connectivity	Ethernet IEEE 802.3 10/100 Mbps, IEEE 802.15.4 and Proprietary wireless, J1939 CAN (output only), and USB 2.0 virtual Ethernet port		
Internet standards	HTTP, HTTPS, TCP/IP, UPnP, UDP		
IP assignment	IPv4 Static or DHCP		
Data storage memory	4 G bytes Micro SD (optional upgrade to 8 or 16 GB)		
Time synchronization	Network time protocol (NTP), Real time clock (RTC), last used, manual entry		
<b>CAN J1939 Output</b>			
J1939 Bit Rate	250 K bps, 500 K bps, 1 M bps		
J1939 Source	Static or dynamic via SAE Name		
J1939 Destination	Static or SAE Name		
J1939 Modes	Tunnel data to destination using PGN 0xEF00, or broadcast data values using PGNs 0xFF00 - 0xFFFF		
Standard bus termination	120 Ω		
<b>Sampling</b>			
Supported node sampling modes	Synchronized, low duty cycle, continuous, periodic burst, event-triggered, and datalogging		
Synchronization beacon interval	1 Hz beacon provides ± 50 μsec node-to-node synchronization		
Synchronization beacon stability	± 5 ppm		
Network capacity	Up to 2000 nodes per RF channel (& per gateway) depending on number of active channels and sampling settings. See system bandwidth calculator: <a href="http://www.microstrain.com/configure-your-system">http://www.microstrain.com/configure-your-system</a>		
<b>Operating Parameters</b>			
Wireless communication range		Typical*	Ideal**
	LXRS	1 km	2 km
	LXRS+	400 m	1 km
Radio frequency (RF) transceiver carrier	License-free 2.405 to 2.480 GHz with 16 channels		
RF communication protocol	IEEE 802.15.4 and Proprietary		
RF transmit power	User-adjustable from 0 dBm to 20 dBm. Power output restricted regionally to operate within legal requirements		
Power source	9.0 to 30.0 V dc (universal 15 V dc, 1.3 A AC/DC converter included in starter kit)		
Power consumption	2850 mW (max), 2400 mW (typ) @ 15 V		
Operating temperature	-40 °C to +85 °C		
<b>Physical Specifications</b>			
Dimensions	147 mm x 110 mm x 23 mm without antenna		
Weight	343 grams		
Enclosure material	Black anodized aluminum		
<b>Integration</b>			
Connectors	USB, RJ45 jack, 26 pin multi-port, 2.1 mm power jack		
Communications cable	USB, Ethernet (CAT6 cable included in starter kit)		
Compatible nodes	All LORD Sensing LXRS® and LXRS+ nodes		

Parameter	Specifications
Firmware	Firmware and OS upgradeable through web interface
Software	SensorCloudSensorConnect™ 8.3 or newer, Windows 7, 8 & 10 compatible
Regulatory compliance	FCC (U.S.), IC (Canada), CE (European Union)

\*Actual range varies with conditions

\*\*Measured with antennas elevated, no obstructions, no RF interferers.

## 12.3 Radio Specifications

The WSDA-2000 employs a 2.4GHz IEEE 802.15.4-compliant radio transceiver for wireless communication. The radio is a direct-sequence spread spectrum radio and can be configured to operate on 16 separate frequencies ranging from 2.405 GHz to 2.480 GHz. Following the 802.15.4 standard, these frequencies are aliased as channels 11 through 26. For all newly manufactured nodes, the default setting is 2.425 GHz (channel 15).

### Contains LORD Sensing 200 Series Radio Module

**FCC ID: XJQMSLINK0007**

**IC ID: 8505A-MSLINK0007**

This device complies with Part 15 of the United States FCC Rules, and Industry Canada's license-exempt RSSs. Operation is subject to the following two conditions: 1) This device may not cause interference, and 2) This device must accept any interference, including interference that may cause undesired operation of the device. Changes or modifications, including antenna changes not expressly approved by LORD Corporation could void the user's authority to operate the equipment.

Cet appareil est conforme à la Partie 15 des Règles de la FCC des États-Unis et aux RSSS exempts de licence d'Industrie Canada. Le fonctionnement est soumis aux deux conditions suivantes: 1) Cet appareil ne doit pas causer d'interférences et 2) Cet appareil doit accepter toute interférence, y compris les interférences pouvant entraîner un fonctionnement indésirable de l'appareil. Les changements ou modifications, y compris les changements d'antenne non expressément approuvés par LORD Corporation, pourraient annuler l'autorisation de l'utilisateur d'utiliser l'équipement.

## 13. Safety Information

This section provides a summary of general safety precautions that must be understood and applied during operation and maintenance of components in the LORD Sensing Wireless Sensor Network.

### 13.1 Disposal and Recycling

 **WARNING**

 **CAUTION**

**NOTICE**



The WSDA<sup>®</sup> - 2000 contains printed circuit boards and electronic components. These items are known to contain toxic chemicals and heavy metals that are harmful to humans health and the environment. Disposal is subject to federal and local laws. Do not discard the device in the trash. Follow proper electronic and battery waste disposal protocol, as dictated by federal and local authorities. Some states have programs for extracting reusable parts for recycling.

## 14. References

### 14.1 Related Documents

Many references are available on the LORD Sensing website including product user manuals, technical notes, and quick start guides. These documents are continuously updated, and new applications are added. They may provide more accurate information than printed or file copies.

Document	Where to find it
Online Wireless Network Calculator	<a href="http://sensorcloud.com/?onlyCalc=true">http://sensorcloud.com/?onlyCalc=true</a>
Product Datasheets	<a href="http://www.microstrain.com/wireless/sensors">http://www.microstrain.com/wireless/sensors</a>
Product Manuals and Technical Notes	<a href="http://www.microstrain.com/support/documentation">http://www.microstrain.com/support/documentation</a>
Product Application Notes	<a href="http://www.microstrain.com/applications">http://www.microstrain.com/applications</a>
NIST Calibration Procedures	<a href="http://www.nist.gov/calibrations/">http://www.nist.gov/calibrations/</a>
ASTM Testing Procedures	<a href="http://www.astm.org/Standard/standards-and-publications.html">http://www.astm.org/Standard/standards-and-publications.html</a>

Table 16 - Related Documents

## 15. Glossary

These terms are in common use throughout the manual:

**A/D Value:** the digital representation of the analog voltages in an analog-to-digital (A/D) conversion. The accuracy of the conversion is dependent on the resolution of the system electronics; higher resolution produces a more accurate conversion. Also referred to as "bits".

**Base Station:** The base station is the transceiver that attaches to the host computer and provides communication between the software and the node(s). It is also referred to as a gateway.

**Burst Sampling:** a mode of operation in which the node is sampled for a fixed window of time (burst) and then repeats that window at set intervals. The burst duration and time between bursts is configurable. Also referred to as periodic burst sampling.

**Calibration:** to standardize a measurement by determining the deviation standard and applying a correction (or calibration) factor

**Configuration:** a general term applied to the node indicating how it is set up for data acquisition. It includes settings such as sampling mode/rate, number of active channels, channel measurement settings, offsets, hardware gain, and calibration values.

**Continuous Sampling:** a mode of operation in which the node is sampled continuously until stopped or sampled continuously for a fixed amount of time

**Coordinated Universal Time (UTC):** the primary time standard for world clocks and time. It is similar to Greenwich Mean Time (GMT).

**Cycle Power:** a command transmitted to the node to reboot it either through a hardware or software switch

**Data Acquisition:** the process of collecting data from sensors and other devices

**Data Logging:** the process of saving acquired data to the system memory, either locally on the node or remotely on the host computer

**DHCP (network):** Dynamic Host Configuration Protocol is the standardized networking protocol used on Internet Protocol (IP) networks, which automatically configures devices that are attached to it by assigning and configuring the device IP address.

**EMI:** Electromagnetic Interference is an inductive or radiated disturbance that can create signal degradation on electrical signals, including loss of data.

**ESD:** Electrostatic Discharge is the sudden flow of electricity that can occur between two charged objects of different potential that come in contact or in close proximity of each other. Static electricity is a common source of ESD.

**Event-Based Sampling:** a mode of operation in which the node sampling is started when a sensor measurement value (threshold) is achieved

**Firmware:** the code that is programmed onto a microcontroller or similar device in an embedded system. It includes device operation commands, conditions, memory allocation, and many other tasks.

**Gateway:** The gateway is a transceiver that attaches to the host computer and provides communication between the software and the node(s). It is also known as a base station.

**Host (computer):** The host computer is the computer that orchestrates command and control of the attached devices or networks.

**LED:** Light Emitting Diode is an indicator light that is used in electronic equipment.

**LOS (Line of Sight):** is used in radio communications to describe the ideal condition between transmitting and receiving antennas in a radio network. As stated it means the antennae are in view of each other with no obstructions.

**LXRS:** Lossless Extended Range Synchronized is the proprietary LORD Sensing data communications protocol used in the wireless sensor network.

**Node:** The node is the wireless transceiver to which the sensor (s) is connected, providing communication with the gateway. The G-Link<sup>®</sup>-LXRS<sup>®</sup>, V-Link<sup>®</sup>-LXRS<sup>®</sup>, and SG-Link<sup>®</sup>-LXRS<sup>®</sup> are examples of nodes manufactured by LORD MicroStrain<sup>®</sup>.

**Node Tester Board:** The node tester board is a device designed by LORD MicroStrain<sup>®</sup> that can be plugged into nodes to test their functionality.

**Offset:** When describing a mathematically-linear relationship, the offset is the value where the line that represents the relationship in a graph crosses the  $y$ -axis. The equation of a straight line is:  $y = mx + b$ , where  $x$  is the  $x$ -axis coordinate,  $y$  is the  $y$ -axis coordinate,  $m$  is the slope and  $b$  is the offset.

**Oversampling:** In signal processing, oversampling is a technique used to achieve increased signal resolution and better noise immunity by recording readings at a higher frequency than the output of the device being measured. In analog-to-digital conversion, the higher the oversampling rate, the better the recreated analog signal.

**Packet:** unit of sampled data



**Periodic Burst Sampling:** a mode of operation in which the node is sampled for a fixed window of time (burst) and then repeats that window at set intervals. The burst duration and time between bursts is configurable. Also referred to as burst sampling.

**Ping:** a byte transmitted by the gateway to the node. The node responds by echoing the byte, indicating communication exists between the node and gateway.

**Range Test:** a continuous string of pings used to validate communication between the gateway and the node over distance and obstruction

**Real Time Clock (RTC):** a computer clock that keeps track of the current time

**RFI:** Radio Frequency Interference is a disturbance in an electrical circuit due to electromagnetic induction or radiation.

**RSSI:** Received Signal Strength Indication is a measurement of the transmission power in a radio signal. It is measured in decibels with reference to 1 milliWatt (dBm).

**RS232:** a serial data communications protocol

**Sensor:** a device that physically or chemically reacts to environmental forces and conditions, producing a predictable electrical signal

**Sleep:** a command transmitted to the node to put it into sleep configuration

**Sampling:** the process of taking measurements from a sensor or device

**Sampling Mode:** the type of sampling that is being utilized, such as event-triggered, continuous, or periodic. The nodes have several sampling modes that employ these types of sampling.

**Sampling Rate:** the frequency of sampling

**Slope:** When describing a mathematically linear relationship, the slope is the steepness of the line that represents that relationship on a graph. The equation of a straight line is:  $y = mx + b$ , where  $x$  is the x-axis coordinate,  $y$  is the y-axis coordinate,  $m$  is the slope, and  $b$  is the offset.

**Streaming:** Streaming is a sampling mode in which all active channels (and the sensors attached to them) are measured, and the acquired data is transmitted to the gateway and software. The data is not written to non-volatile memory during streaming. Streaming can either be finite (have a user defined start and end time) or continuous (continued until the power is cycled on the node).

**Synchronized Sampling:** a sampling mode that automatically coordinates all incoming node data to a particular gateway. This mode is designed to ensure data arrival and sequence.

**Transmission rate:** the number of data packets per transmission window, measured in seconds. Depending on the sampling mode and settings it will be between 1 and 64 packets/second.

**Transmission window:** the time allowed for one data transmission at the automatically determined transmission rate

**USB:** Universal Serial Bus is a serial data communications protocol

**WSN:** Wireless Sensor Network describes a distribution of sensors and data acquisition equipment that autonomously monitors environmental characteristics, such as temperature, pressure, and strain.