

TC-Link[®]-200-OEM

Wireless Single Channel Temperature Sensor Node





LORD Sensing Systems
459 Hurricane Lane
Suite 102
Williston, VT 05495
United States of America

Phone: 802-862-6629

Fax: 802-863-4093

9:00 AM to 5:00 PM (Eastern Time US & Canada)

<http://www.microstrain.com>
sensing_support@LORD.com
sensing_sales@LORD.com

Document 8500-0095 Revision A

Subject to change without notice.

Table of Contents

| | |
|---|-----------|
| 1. Wireless Sensor Network Overview | 5 |
| 2. Node Overview | 6 |
| 2.1 Configuration Options | 7 |
| 2.2 Interface and Indicators | 8 |
| 2.3 Node Operational Modes | 9 |
| 3. System Operation | 10 |
| 3.1 Software Installation | 10 |
| 3.2 Gateway Communication | 11 |
| 3.3 Connect to Nodes | 12 |
| 3.3.1 Automatic Node Discovery on Same Frequency | 12 |
| 3.3.2 Automatic Node Discovery on Different Frequency | 12 |
| 3.3.3 Manually Add Node | 14 |
| 4. Wireless Sensor Configuration | 16 |
| 4.1 Hardware Configuration | 16 |
| 4.2 Calibration Configuration | 17 |
| 4.3 Sampling Configuration | 18 |
| 4.4 Power | 20 |
| 5. Wireless Sensor Sampling Configuration | 21 |
| 5.1 Start Collecting Data | 21 |
| 5.2 Network Options | 22 |
| 5.3 Sampling Operations Options | 23 |
| 5.4 Output Operation | 24 |
| 6. Data Handling | 25 |
| 6.1 SensorCloud | 26 |
| 6.1.1 Connect to SensorCloud | 26 |
| 6.1.2 Navigating Menus | 26 |

| | | |
|------------|------------------------------------|-----------|
| 6.2 | SensorConnect | 29 |
| 6.2.1 | Using Dashboards and Widgets | 29 |
| 6.2.2 | Navigating Graphs | 29 |
| 6.2.3 | Widgets Options | 30 |
| 6.2.4 | Time Series Widget Menu | 30 |
| 6.2.5 | Exporting Data Files | 31 |
| 7. | Node Installation | 32 |
| 7.1 | Mounting Recommendations | 32 |
| 7.1.1 | Range Test | 34 |
| 8. | Troubleshooting | 35 |
| 8.1 | Troubleshooting Guide | 35 |
| 8.2 | Updating Node Firmware | 38 |
| 8.3 | Repair and Calibration | 39 |
| 9. | Specifications | 40 |
| 9.1 | Physical Specifications | 40 |
| 9.2 | Operating Specifications | 41 |
| 10. | Safety Information | 43 |
| 10.1 | Powering the Node | 43 |
| 10.2 | ESD Sensitivity | 43 |
| 10.3 | Disposal and Recycling | 43 |
| 10.4 | Radio Specifications | 44 |
| 11. | References | 45 |
| 11.1 | Related Documents | 46 |
| 11. | Appendix | 47 |
| 11.2 | Accuracy and Resolution | 47 |
| 11.2.1 | Thermocouple | 47 |
| 11.2.2 | Resistance Thermometers | 47 |

12. Glossary48

1. Wireless Sensor Network Overview

The LORD Sensing Wireless Sensor Network is a high-speed, scalable, sensor data acquisition and sensor networking system. Each system consists of wireless sensor interface nodes, a data collection gateway, and full-featured user software platforms based on the LORD Sensing Lossless Extended Range Synchronized (LXRS) and LXRS+ data communications protocols. Bi-directional wireless communication between the node and gateway enables sensor data collection and configuration from up to two kilometers away. Gateways can be connected locally to a host computer or remotely via local and mobile networks. Some gateways also feature analog outputs for porting sensor data directly to stand-alone data acquisition equipment.



The selection of available nodes allows interface with many types of sensors, including accelerometers, strain gauges, pressure transducers, load cells, torque and vibration sensors, magnetometers, 4 to 20 mA sensors, thermocouples, RTD sensors, soil moisture and humidity sensors, inclinometers, and orientation and displacement sensors. Some nodes come with integrated sensing devices such as accelerometers. System sampling capabilities include lossless synchronized sampling, continuous and periodic burst sampling, and data logging. A single gateway can coordinate many nodes of any type, and multiple gateways can be managed from one computer with the SensorConnect™ and SensorCloud™ software platforms. Integration to customer systems can be accomplished using OEM versions of the sensor nodes and leveraging the LORD Sensing data communications protocol.

Common wireless applications of LORD Sensing Sensing Systems are strain sensor measurement, accelerometer platforms, vibration monitoring, energy monitoring, environmental monitoring, and temperature monitoring.

2. Node Overview

The TC-Link-200-OEM is a small, wireless, low-cost, single channel temperature sensor node ready for OEM integration. Featuring one input channel supporting Thermocouples, Resistance Thermometers and Thermistors, the TC-Link-200-OEM enables high resolution, low noise data collection at sample rates up to 128 Hz. Users can easily program nodes for continuous and event-triggered sampling with SensorConnect.

TC-Link-200-OEM inputs range between 0.01 to 0.02° C resolution with a full scale measurement accuracy between ± 0.13 to ± 0.5 ° C. The node can log data to internal memory, transmit real-time synchronized data, and it supports event driven triggers with both pre- and post- event buffers.

To acquire sensor data, the TC-Link-200-OEM is used with a LORD Sensing WSDA gateway, and comes with the following configuration options.



Figure 1 - TC-Link-200-OEM

2.1 Configuration Options

TC-Link-200-OEM sensor node comes with the following configuration options.

| Product | Model | Part Number |
|-------------------------|--|-------------|
| TC-Link-200-OEM | Integrated chip antenna | 6310-4100 |
| | U.FI interface: Stub antenna, 2" cable | 6310-4101 |
| Calibration certificate | -- | -- |

Table 1 - TC-Link-200-OEM Configuration Options

2.2 Interface and Indicators

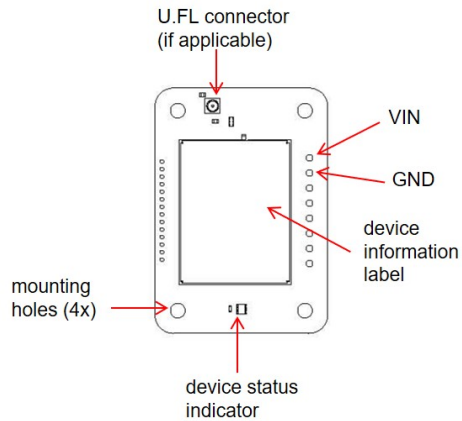

Figure 2 - Interface and Indicators

| Indicator | Behavior | Node Status |
|-------------------------|----------------------------------|--|
| Device status indicator | OFF | Node is OFF |
| | Rapid green flashing on start-up | Node is booting up |
| | 1 (slow) green pulse per second | Node is idle and waiting for a command |
| | 1 green blink every 2 seconds | Node is sampling |
| | Blue LED during sampling | Node is resynchronizing |
| | Red LED | Built-in test error |

Table 2 - Indicator Behaviors

2.3 Node Operational Modes

Sensor nodes have three operational modes: *active*, *sleep*, and *idle*. When the node is sampling, it is in active mode. When sampling stops, the node is switched into idle mode, which is used for configuring node settings, and allows toggling between sampling and sleeping modes. The node will automatically go into the ultra low-power sleep mode after a user-determined period of inactivity. The node will not go into sleep mode while sampling.

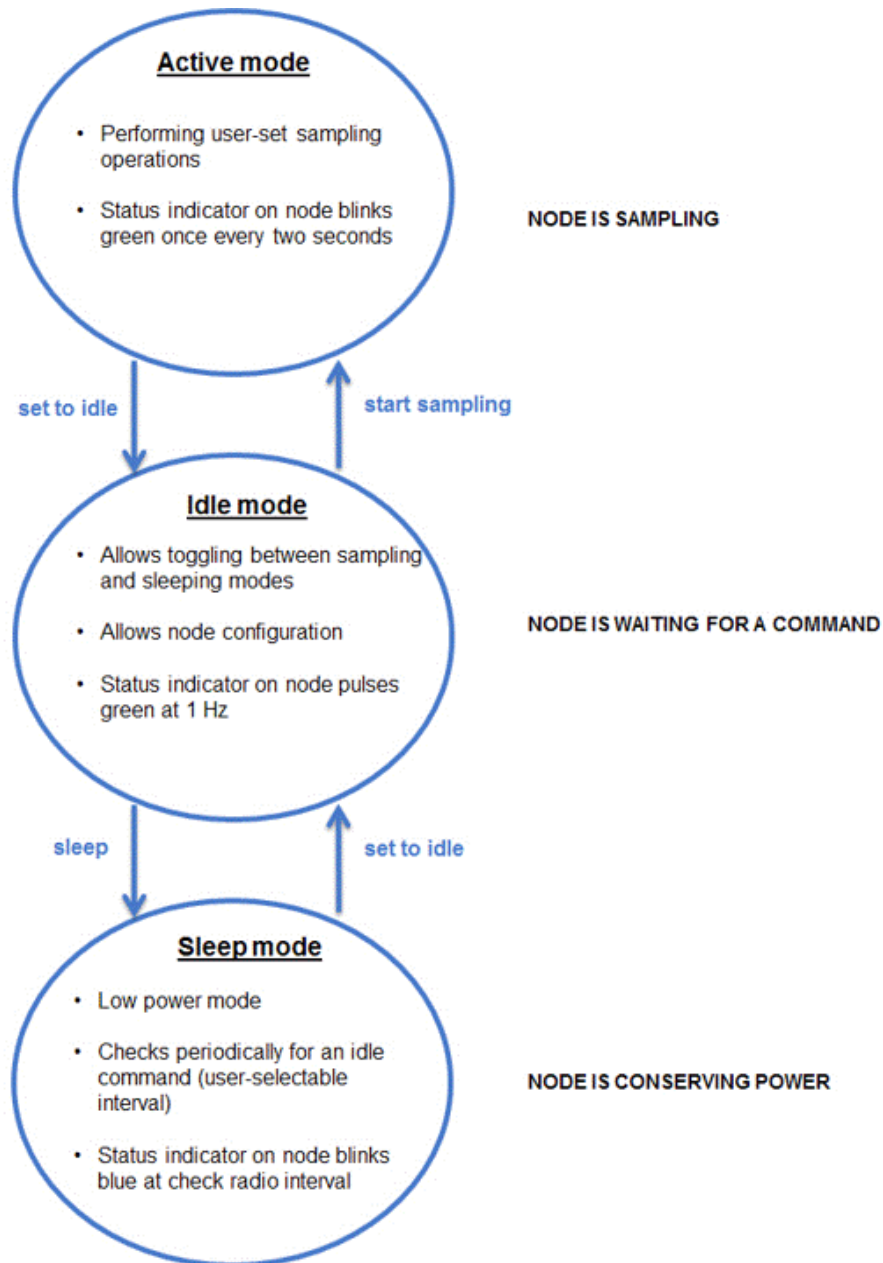

Figure 3 - Node Operational Modes

3. System Operation

3.1 Software Installation

Install the **SensorConnect** software on the host computer before connecting any hardware. Access the free software download on the LORD Sensing website at:



<http://www.microstrain.com/software>

SensorCloud is an optional data collection, visualization, analysis, and remote management tool. It is based on cloud computing technology and is accessed directly from a web connection. Automatic, real-time data collection is available through Ethernet gateways, such as the WSDA-1500 Data files can also be uploaded. For more information go to: <http://www.sensorcloud.com/>.



3.2 Gateway Communication

Drivers for the USB gateways are included the SensorConnect software installation. With the software installed, the USB gateway will be detected automatically whenever the gateway is plugged in.

1. Power is applied to the gateway through the USB connection. Verify the gateway status indicator is illuminated, showing the gateway is connected and powered on.
2. Open the SensorConnect™ software.
3. The gateway should appear in the Controller window automatically with a communication port assignment. If the gateway is not automatically discovered, verify the port is active on the host computer, and then remove and re-insert the USB connector.

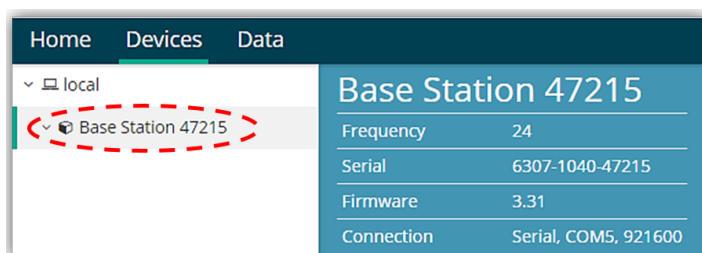

Figure 4 - USB Gateway Communication

3.3 Connect to Nodes

Several methods can be used in SensorConnect to establish communication with the nodes: the automatic node discovery on the same frequency, automatic node discovery on a different frequency, and add node manually.

3.3.1 Automatic Node Discovery on Same Frequency

If the base and node are on the same operating frequency, the node will populate below the Base Station listing when powering on the TC-Link-200-OEM.

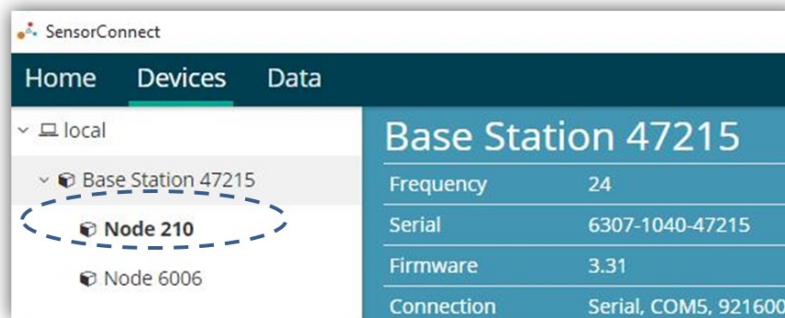

Figure 5 - Node Discovered On Same Frequency

3.3.2 Automatic Node Discovery on Different Frequency

If a red circle with a number appears next to the Base Station, the node may be operating on a separate radio channel. Select the Base Station and then select the Nodes on Other Frequencies tile.

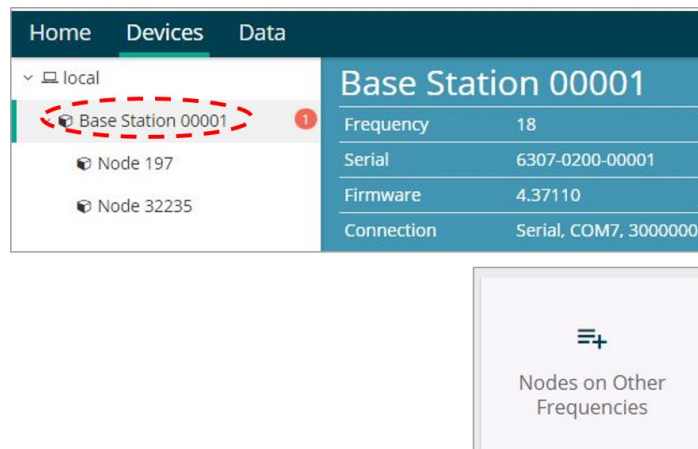

Figure 6 - Node On Other Frequency

Highlight the new node being added and select Move Node to Frequency (#).

Select a Node to move to this BaseStation's frequency.

| Node | Frequency | Last Heard |
|-------|-----------|---------------|
| 61506 | 13 | 6 minutes ago |
| 62884 | 11 | 8 minutes ago |

Refresh

Move Node to Frequency 24

Figure 7 - Move Node

3.3.3 Manually Add Node

Adding a node manually requires entering the node address and its current frequency setting.

Figure 8 - Add Node By Address

If the node was successfully added, two confirmation messages will appear and it will be listed under the Base Station.

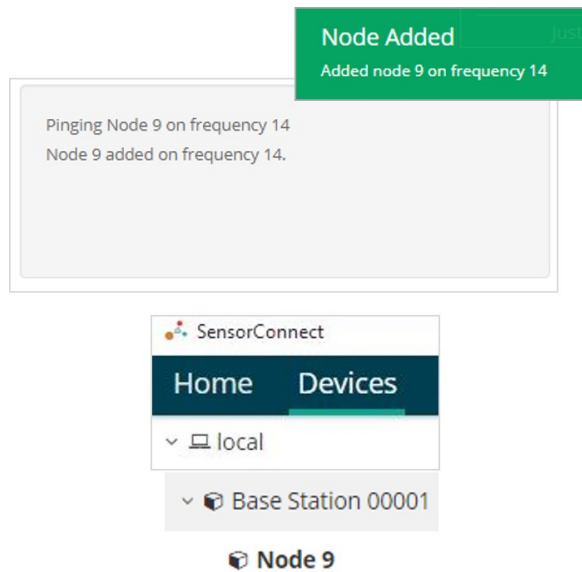

Figure 9 - Add Node Confirmation

If the node failed to be added, a failure message will appear. This means the node did not respond to the base station which could indicate the node is not in idle mode or it may be on another frequency. If "Add Node Anyway" is selected, it will associate that node with the channel entered but it is likely there will be a communication error. If the node was not in idle, move the base station to the frequency of the node and issue a "Set to Idle" command.

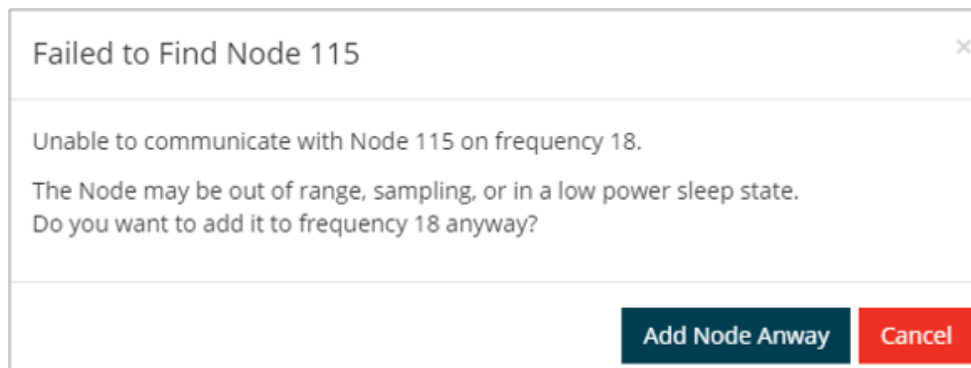

Figure 10 - Failure to Add Node

4. Wireless Sensor Configuration

4.1 Hardware Configuration

Node settings are stored to non-volatile memory and may be configured using SensorConnect. This chapter describes the user-configurable settings. For details on thermocouple and resistance thermometer accuracy and resolution, [See Appendix on page 47](#)

Wireless Node Configuration

| Hardware | Calibration | Sampling | Power | | | | | | | | |
|---|-----------------------------------|----------------------|-----------|------------|-----------------|------------------------|-----------------------------------|------------------------|-----|----------------------|--------|
| <p>Temperature Sensor</p> <table style="width: 100%; border-collapse: collapse;"> <thead> <tr> <th style="width: 25%;">Channel(s)</th> <th style="width: 25%;">Transducer Type</th> <th style="width: 25%;">Sensor Type</th> <th style="width: 25%;">Wire Type</th> </tr> </thead> <tbody> <tr> <td>1 - Temperature Sensor</td> <td>RTD</td> <td>Uncompensated (None)</td> <td>3 Wire</td> </tr> </tbody> </table> | | | | Channel(s) | Transducer Type | Sensor Type | Wire Type | 1 - Temperature Sensor | RTD | Uncompensated (None) | 3 Wire |
| Channel(s) | Transducer Type | Sensor Type | Wire Type | | | | | | | | |
| 1 - Temperature Sensor | RTD | Uncompensated (None) | 3 Wire | | | | | | | | |
| <p>Low Pass Filter ⓘ</p> <table style="width: 100%; border-collapse: collapse;"> <thead> <tr> <th style="width: 25%;">Channel(s)</th> <th style="width: 75%;">Filter Cutoff</th> </tr> </thead> <tbody> <tr> <td>1 - Temperature Sensor</td> <td>2.6 Hz (120db 50/60 Hz rejection)</td> </tr> </tbody> </table> | | | | Channel(s) | Filter Cutoff | 1 - Temperature Sensor | 2.6 Hz (120db 50/60 Hz rejection) | | | | |
| Channel(s) | Filter Cutoff | | | | | | | | | | |
| 1 - Temperature Sensor | 2.6 Hz (120db 50/60 Hz rejection) | | | | | | | | | | |
| <p>Input Range</p> <table style="width: 100%; border-collapse: collapse;"> <thead> <tr> <th style="width: 25%;">Channel(s)</th> <th style="width: 75%;">Input Range</th> </tr> </thead> <tbody> <tr> <td>1 - Temperature Sensor</td> <td>±1.25 V or 0 to 5100 ohms</td> </tr> </tbody> </table> <p style="text-align: center; background-color: #e0f2f1; padding: 5px; margin-top: 10px;">Note: This setting is only used when the Sensor Type is set to Uncompensated.</p> | | | | Channel(s) | Input Range | 1 - Temperature Sensor | ±1.25 V or 0 to 5100 ohms | | | | |
| Channel(s) | Input Range | | | | | | | | | | |
| 1 - Temperature Sensor | ±1.25 V or 0 to 5100 ohms | | | | | | | | | | |

Figure 11 - Hardware Configuration Menu

- **Temperature Sensor**- There are three Transducer Type options: Thermocouple, RTD and Thermistor. Sensor Type options change depending on the transducer type selected. There is a drop down menu for selecting Wire Type for RTDs.
- **Input Range** - The input range is automatically determined based on Sensor Type unless the Sensor Type is Uncompensated. Available ranges are ± 1.35 V, ± 1.25 V, ± 625 mV, ± 312.5 mV, ± 156.25 mV, ± 78.125 mV, ± 39.0625 mV, or ± 19.5313 mV.
 - **Uncompensated**- Input ranges are defined in mV for Uncompensated Thermocouples and in Ohms for Uncompensated RTDs and Thermistors. This field does not change per Transducer Type setting.
- **Low Pass Filter** - An adjustable digital decimation filter allows low-pass filtering between 2.6 Hz and 294 Hz.

4.2 Calibration Configuration

The coefficients are applied automatically by SensorConnect when the node is outputting data in the assigned unit: Celsius, Fahrenheit or Kelvin.

| Channel(s) | Unit | Calibration |
|---------------------------|---------|-----------------------------------|
| 1 - Temperature Sensor | Celsius | $= (1 \times ^\circ\text{C}) + 0$ |
| 2 - CJC Temperature | Celsius | $= (1 \times ^\circ\text{C}) + 0$ |

Figure 12 - Wireless Sensor Calibration Menu

4.3 Sampling Configuration

There are three user-set sampling options for the TC-Link-200-OEM, including Lost Beacon Timeout, Diagnostic Info Interval, and Storage Limit Mode, in the Wireless Node Configuration > Sampling menu.

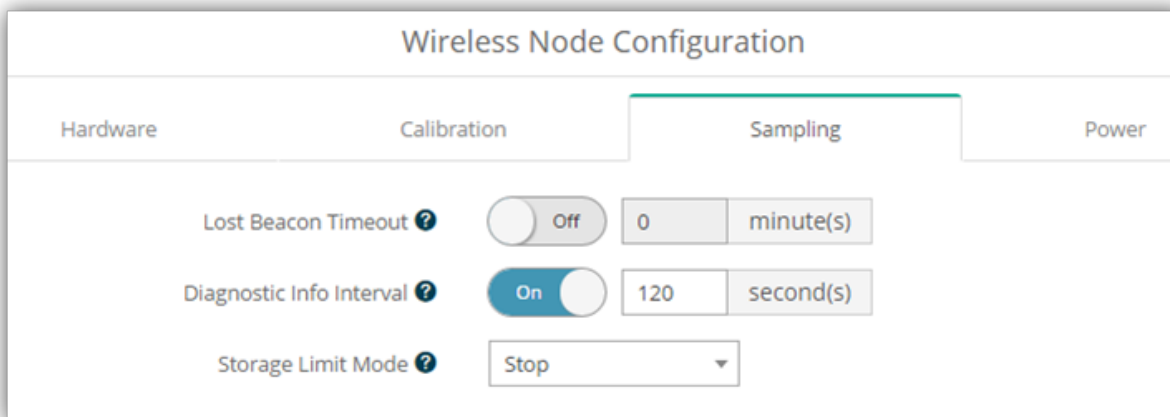

Figure 13 - Sampling Configuration Menu

- **Lost Beacon Timeout** - When the node is running in a synchronized network, it periodically synchronizes its time clock to a beacon broadcasted from the WSDA gateway. The Lost Beacon Timeout feature means that the node will automatically stop sampling and transmitting data after the beacon has been lost for the configured amount of time. The node will save power in this state without user intervention until the beacon returns. Within two minutes of the beacon returning, the node will automatically begin sampling and transmitting data again.
- **Diagnostic Info Interval** - At the defined transmit interval, the wireless sensor will report diagnostic information. The node will continue to transmit this diagnostic information in all operating modes, including Idle, Sleep, and Run modes. ([See Table 3 - below](#)).
- **Storage Limit Mode** - The Storage Limit Mode applies when the node is datalogging to internal flash. The two available options are: 1) **Stop** - when the node fills up its flash memory, it will stop logging data. It is important to erase old data before starting new data logging sessions, and 2) **Overwrite** - when the node fills up its flash memory, new data will overwrite old data in a first-in, first-out method.

The contents of the diagnostic packet may be viewed in the Data tab within SensorConnect.

| Description | Data Values | Data Type | Unit |
|------------------------------|--|-----------|---------|
| Current State | 0 = Idle 1 = Deep sleep 2 = Active run 3 = Inactive run | uint8 | -- |
| Run Time | Idle | uint32 | seconds |
| | Deep sleep | uint32 | seconds |
| | Active run | uint32 | seconds |
| | Inactive run | uint32 | seconds |
| Reset Counter | -- | uint16 | counts |
| Built in Test Result | 0 = no errors | uint32 | -- |
| Internal Temperature | Valid range: -40 to 125° C | sint8 | Celsius |
| Low Battery Indicator | 0 = good 1 = low 2 = critical (sensor will stop sampling) | uint8 | -- |
| External Power | 0 = not connected 1 = external power connected | uint8 | -- |
| Sample Info | Sweep index | uint32 | counts |
| | Bad sweep count | uint32 | counts |
| Transmission Info | Total transmissions | uint32 | counts |
| | Total retransmissions | uint32 | counts |
| | Total dropped packets | uint32 | counts |
| Synchronization Info | Synchronization attempts | uint32 | counts |
| | Synchronization failures | uint32 | counts |
| | Seconds since last synchronization | uint32 | counts |
| Event Trigger Index | -- | uint16 | counts |

Table 3 - Diagnostic Packet

4.4 Power

There are multiple user-set power options for the TC-Link-200-OEM, including Default Operation Mode, User Inactivity Timeout, Check Radio Interval, and Transmit Power, in the Wireless Node Configuration > Power menu.

The screenshot shows the 'Wireless Node Configuration' interface with the 'Power' tab selected. The settings are as follows:

| Setting | Value |
|-------------------------|--------------------|
| Default Operation Mode | Idle |
| User Inactivity Timeout | On, 7200 second(s) |
| Check Radio Interval | 10 second(s) |
| Transmit Power | 20 dBm |

Figure 14 - Node Configuration Power Menu

- **Default Operation Mode** - When power is applied, the node will enter the Default Operation Mode.
- **User Inactivity Timeout** - While in Idle mode, the node will automatically enter Sleep mode if it does not receive any commands for the selected amount of time. If Sample is selected under Default Operation Mode, the node will automatically re-enter the sample mode it performed last with all current settings. Disable User Inactivity Timeout to avoid the node automatically changing states.
- **Check Radio Interval** - While in Sleep and Sample modes, the Check Radio Interval sets the frequency the node checks the radio channel for a "Set to Idle" command. Decreasing the Check Radio Interval will shorten the amount of time it takes to wake the node into Idle mode with the cost of decreasing battery life. Increasing the Check Radio Interval could increase battery life at the cost of increasing the amount of time it takes to wake the node into its Idle mode.
- **Transmit Power** - Set the output power of the radio to a value between 0dBm to +20dBm. The output power will effect communication range and also battery life.

5. Wireless Sensor Sampling Configuration

5.1 Start Collecting Data

There are several ways to collect data from the TC-Link-200-OEM, including from a single node, a network of nodes, or restarting the last used sampling mode

- **Single node** - From Devices, select Node address > Sample > Apply and Start Network to begin collecting data from a single wireless sensor.

| Network Settings: <input checked="" type="checkbox"/> Synchronized ? <input checked="" type="checkbox"/> Lossless ? | | | | |
|---|------|-------------|---------------------|--------------------------|
| <input checked="" type="checkbox"/> | Node | Channels | Sampling | Data Type ? |
| <input checked="" type="checkbox"/> | 1003 | 1 Channel ▾ | 1 Hz continuously ▾ | float (4 bytes) ▾ |

Figure 15 - Single Node Sampling

- **Network of Nodes** - From Devices, select > Base Station > Sampling Network > Nodes to be sampled > Apply and Start Network to start collecting data from a network of wireless sensors.

| <input checked="" type="checkbox"/> | Node | Channels | Sampling |
|-------------------------------------|------|-------------|---------------------|
| <input checked="" type="checkbox"/> | 1003 | 1 Channel ▾ | 1 Hz continuously ▾ |
| <input checked="" type="checkbox"/> | 2003 | 1 Channel ▾ | 1 Hz continuously ▾ |
| <input checked="" type="checkbox"/> | 2005 | 1 Channel ▾ | 1 Hz continuously ▾ |

Figure 16 - Network of Nodes Sampling

5.2 Network Options

There are two network settings available for the TC-Link-200-OEM: Synchronized and Lossless .

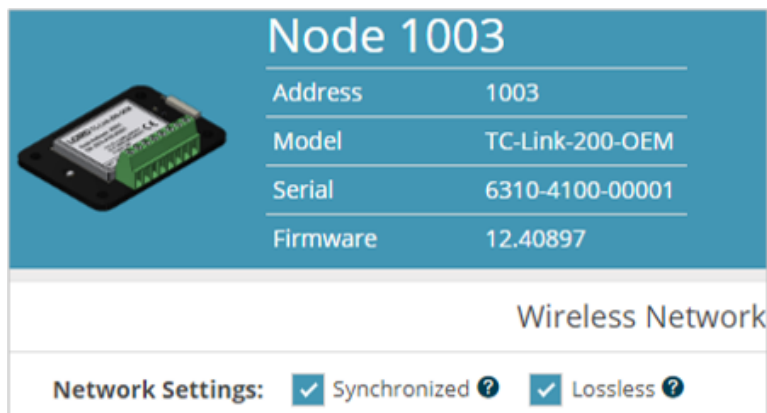

Figure 17 - Network Settings Menu

- **Synchronized** - All nodes in the network will periodically synchronize their time clocks to a beacon that is broadcasted by the **WSDA gateway**. Each beacon contains a UTC timestamp, allowing nodes to timestamp their collected data within an accuracy of +/- 50 us. Each node will also buffer data and transmit this data in time-slots allocated prior to sampling. Using time-slots assures the transmissions will not “collide”, or corrupt each other. It also provides a means for efficiently scaling the size of the network to allow as much data throughput as possible.

Deselect Synchronized if low latency, or the lowest power at slow sample rates, is required.

- **Lossless** - The user can achieve near lossless data collection in most environments through the use of data buffering, radio acknowledgments, and retransmissions. Each node buffers collected data and timestamps to an internal 2 Mbit FIFO buffer. For each transmission, data is pulled from this buffer. The node will retransmit data until this acknowledgment is received. Inherent overhead in the transmission scheduling protocol assures the node time to recover from periods of poor radio communication. This feature allows lossless performance in environments where the node achieves as low as 50% packet error rate. It also allows for operation in situations where the gateway and node move in and out of range of each other.

The Lossless feature is only available when Synchronized is enabled. Disable Lossless if the application requires consistent latency or can tolerate lost data.

5.3 Sampling Operations Options

The three sampling options for the TC-Link-200-OEM are Continuously, Limited or Event Triggered.

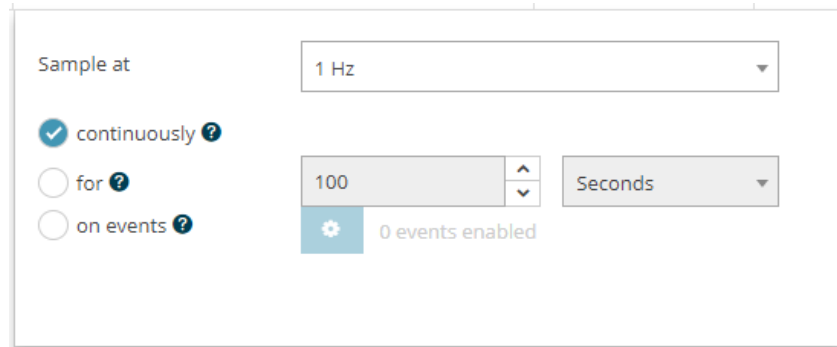

Figure 18 - Sampling Operations Menu

- **Continuous** - Collect data continuously at the configured sample rate. All data is transmitted and/or logged to flash memory until a Set to Idle command is received.
- **Limited** - Automatically stop sampling and return to Idle mode after the configured time duration is met.
- **Event Triggered** - Collect data continuously at a fixed sample rate for increased battery life, reduced data sets, and increased network size. Only transmit/log the data if one of the configured threshold conditions has been met. When the condition is met, all active sensor channels will transmit/log both pre- and post-event data.

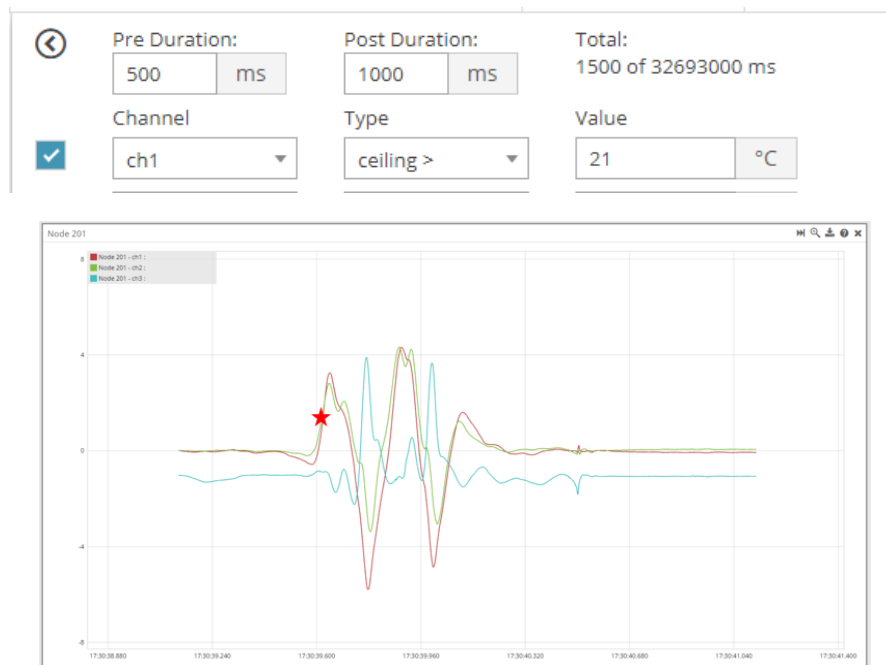

Figure 19 - Event Triggered Sampling

5.4 Output Operation

There are three options for managing data acquired from the TC-Link-200-OEM. The user can transmit collected data, log the data to flash memory, or do both.

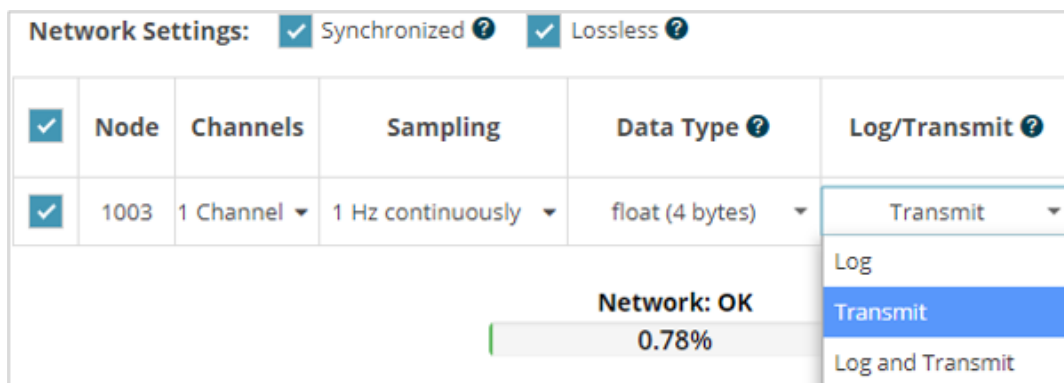

Figure 20 - Data Outputs

6. Data Handling

Data acquired through SensorConnect is automatically saved on the host computer. Saved data can be uploaded to SensorCloud. Ethernet gateways provide the option to automatically port the data to SensorCloud during data acquisition for near real-time display and aggregation. Ethernet gateways can also be configured to save data locally to internal memory for future upload to the host computer or SensorCloud.

SensorCloud is based on cloud computing technology and is designed for long term collecting and preservation of data. Features include time series and visualization graphing, automated alerts, and data interpretation tools such as data filtering, statistical analysis, and advanced algorithm development with the integrated MathEngine® interface. Leveraging the open source API, SensorCloud can also be used to collect data from other LORD Sensing sensor products or third-party systems. Basic SensorCloud services are available to all users free of charge at: <http://www.sensorcloud.com/>.

6.1 SensorCloud

6.1.1 Connect to SensorCloud

Go to the SensorCloud website and select sign-in to enter the log-in credentials, or register as a new user if needed: <http://www.sensorcloud.com/>

SensorCloud Login

Email

Password

[Forgot your password?](#)

Don't have an account? [Sign Up](#) now!

Figure 21 - SensorCloud Log-in or Register

6.1.2 Navigating Menus

The SensorCloud interface has **six main views**. When logging in as a registered user, the Device view is the default. Navigate to other views by clicking the view name at the top of the page (*Figure 22 - SensorCloud Menu Views*). The Data and Settings views are only available once a device is selected from the device list.

Device lists - select a device to access Data and Settings menus

| DEVICE | PLAN | CONFIGURATION | LAST HEARD FROM | DATA (JUN 18 - JUL 18) | | TOTAL STORAGE |
|-------------------------------|------------------------|---------------|-----------------|-------------------------|------------------------------|---------------|
| | | | | USAGE | | |
| New Device OAP100280CH7K9H | Basic UNCHANGED | Configuration | | Transactions: 0.00K/25K | Monthly Storage: 0.00/10 MDP | 0.00 MDP |
| W063140205021034 | Basic UNCHANGED | Configuration | 7/21/14 11:30 | Transactions: 0.00K/25K | Monthly Storage: 0.00/10 MDP | 1.88 MDP |

| DEVICE | CONFIGURATION | LAST HEARD FROM |
|---|---------------|-----------------|
| MSText (andy) ##90015C91C7A80 | Configuration | 7/15/15 12:02 |
| CallFrac - Heavy Loading Run Up 9-4-13 OAP100C385K4URZ | Configuration | |

| DEVICE | LAST HEARD FROM |
|------------------------------------|-----------------|
| Demo Structure OAP10039T2K5FD4X | 7/14/15 14:36 |

Figure 22 - SensorCloud Menu Views

Device - The device list shows every Ethernet gateway and API device associated with the SensorCloud account, including owned, shared, and demo devices. This view provides links to each device’s SensorCloud subscription plan, configuration options, and a summary of last communications and data transactions.

Account - The account view is for logistic management of the SensorCloud account, such as changing the log-in password, accessing user email, and reviewing billing information.

CSV Uploader - The data upload feature enables data from any source (such as non-Ethernet LORD Sensing gateways, or third-party sensor) to be uploaded to the SensorCloud platform. The data must be in the LORD Sensing CSV format.

Data - This view is only available after a device is selected. It displays data that is collected from sensor nodes or uploaded from files. Data selections are listed by node channel or a user-defined label and can be enabled for display in the graph window. The interactive graph has navigational features such as panning, zooming, and an overview graph for single-click access to data points or ranges. There are also use and management features such as viewing the meta-data and downloading, embedding, and tagging data graphs.



Figure 23 - SensorCloud Data View

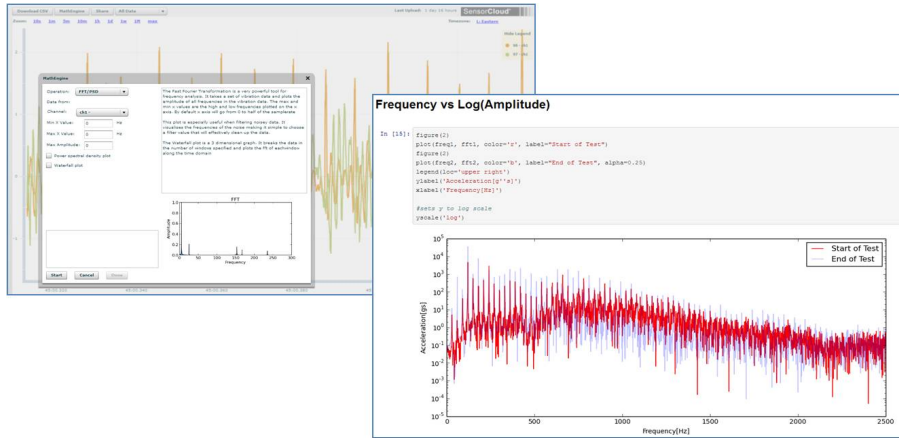

Figure 24 - MathEngine[®] View

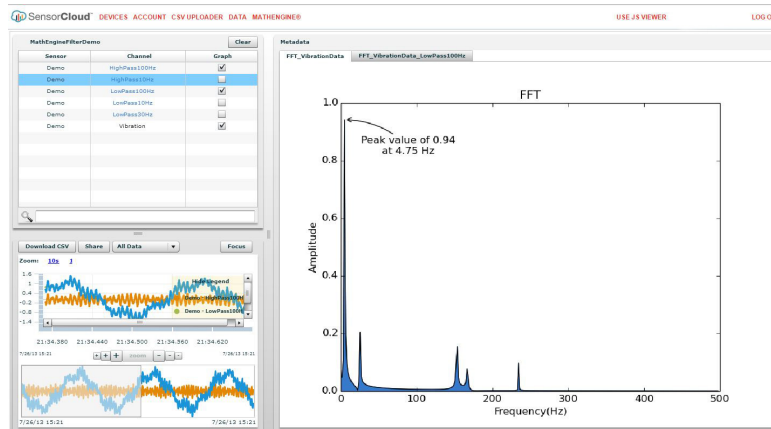

Figure 25 - FFT Graph in SensorCloud

6.2 SensorConnect

6.2.1 Using Dashboards and Widgets

Collected data is viewed on the Data page through the creation of dashboards and widgets. Think of dashboards as individual pages and widgets as an illustration on the page. Create multiple data widgets on each dashboard to display sampled data as a time-series graph, text chart, or a simple gauge that only displays the most current reading. This format provides an easy way to organize many sensors and networks, and it allows the information to be displayed in the most appropriate layout.

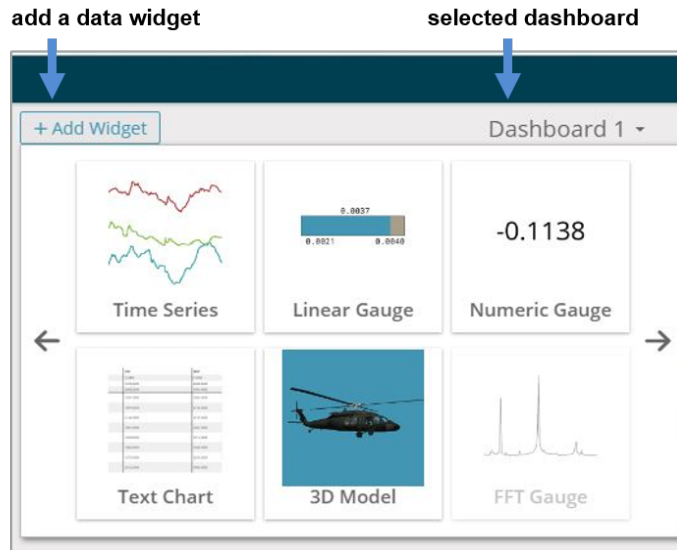

Figure 26 - Viewing Data

6.2.2 Navigating Graphs

Use the mouse along with the shift and control keys inside the graph window to adjust the data view.

| Control | Action |
|---|------------------------|
| Mouse wheel | Zoom in/out on x-axis |
| Shift + mouse wheel | Zoom in/out on y-axis |
| Mouse double-click | Zoom to extends |
| Shift + mouse left-click, drag left/right | Zoom window left/right |
| Shift + mouse left-click, drag up/down | Zoom window up/down |
| Ctrl + mouse left-click, drag | Zoom box |

Table 4 - Graph View Controls

6.2.3 Widgets Options

The widget configuration menu is different for each type of widget but typically includes sensor or channel selections and widget settings such as titles and legends.

After adding a widget, left click to select and configure it in the Channels and Settings left sidebar menu. Under Channels, the channel(s) for the widget can be enabled and disabled.

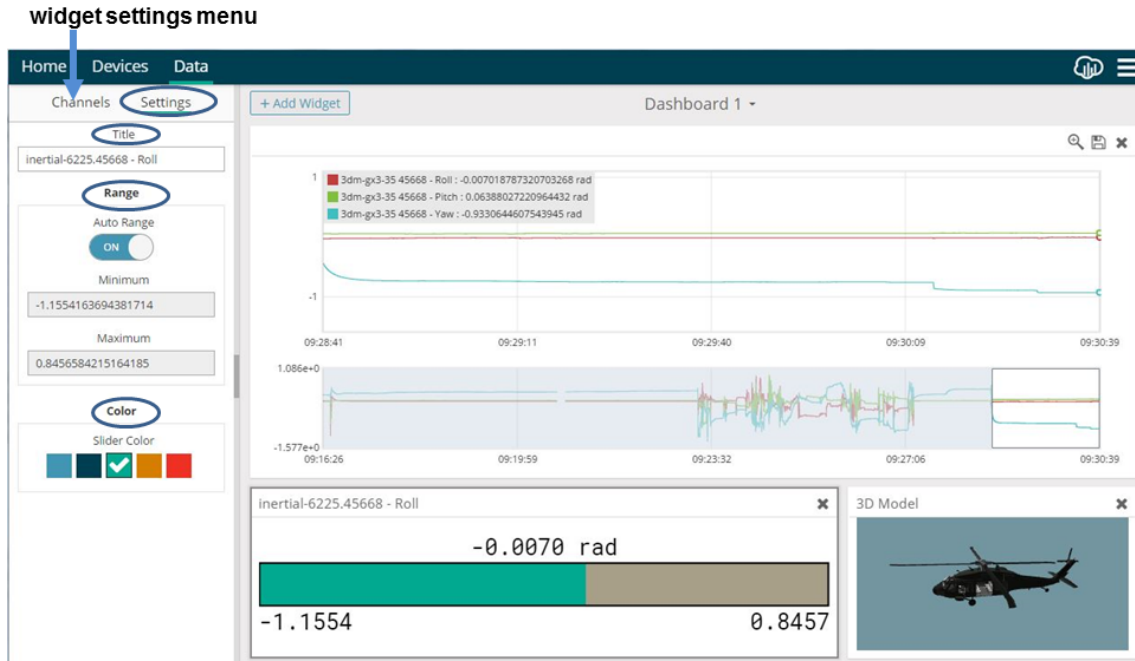

Figure 27 - Widget Settings Menu

6.2.4 Time Series Widget Menu

The Time Series Widget menu has two features to help optimize sensor data collection for export to a .csv file. *Snap to Latest* captures the most recent data and *Zoom* isolates specific events from a larger data sample (see [Exporting Data Files on page 31](#)).



Figure 28 - Time Series Widget Menu

6.2.5 Exporting Data Files

To export data to a .csv file, select the Export Data button on the Time Series widget > Export > name the document > save to the preferred location on the host computer.

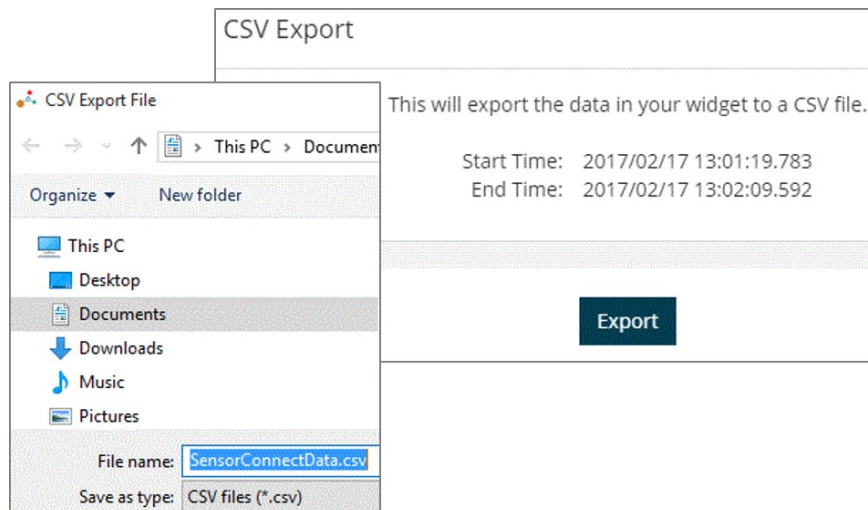

Figure 29 - Exporting Data

7. Node Installation

7.1 Mounting Recommendations

There are 4 mounting holes on the TC-Link-200-OEM for 2-56 UNC screws.

The node can be mounted in any orientation, but it is recommended that it is mounted in a way that optimizes wireless communications.

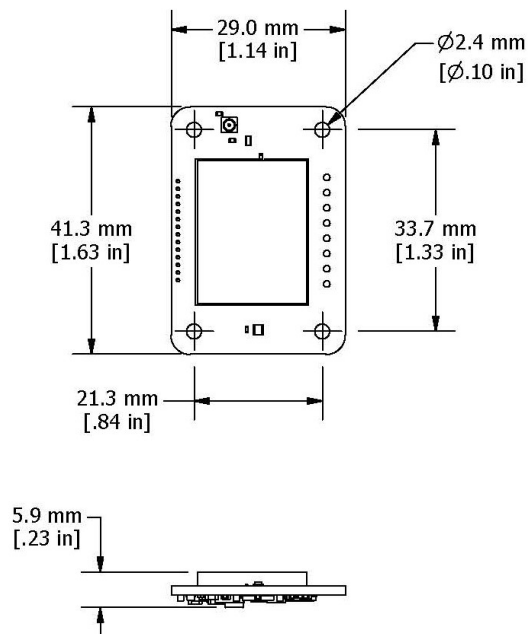

Figure 30 - Mounting the Node

NOTE

In the event of communication difficulties, it may be necessary to disable WIFI on the host computer, or use a USB extender when collecting data.

The best method for ensuring optimal radio communication is to conduct an RF survey of the installation site. This is easily accomplished in SensorConnect by using the range test feature to quantify the radio signal strength (RSSI) in various scenarios. [See Range Test on page 34](#) for instructions on using SensorConnect for measuring RSSI. The following are general guidelines for maximizing communication range:

- **Line of Sight (LOS)** between the node and gateway. Try to avoid obstructions such as buildings, terrain, vegetation, or other physical barriers.
- **Increase the Mounting Height** of the node to allow a clearer LOS path to the gateway. Height above the ground is also important because reflections off of the ground can interfere at the receiver. Generally, the higher above the ground the better.
- **Minimize Radio Frequency Interference (RFI)** from other wireless devices, especially those operating in the same frequency range. This includes other nodes and 2.4 GHz WIFI routers. If other wireless devices are required nearby, mount them at different heights to minimize interference. Additionally, a different radio frequency may be selected using SensorConnect software.
- **Minimize Electromagnetic Interference (EMI)** such as that which is generated by power transmission equipment, microwaves, power supplies, and other electromagnetic sources.
- **Metal Objects** in close proximity to either antenna, particularly ferrous metals such as steel and iron, can be problematic for wireless communications. The larger the object, the greater the influence.

7.1.1 Range Test

After establishing communication between node and gateway, use the range test feature in SensorConnect to monitor the signal strength and to optimally position the nodes, gateway, and antennae for installation. Maximum achievable range is determined by the gateway and node power settings (found in the device Configure menu) and is highly dependent on the physical environment surrounding the devices.

1. Select the node name > Range Test

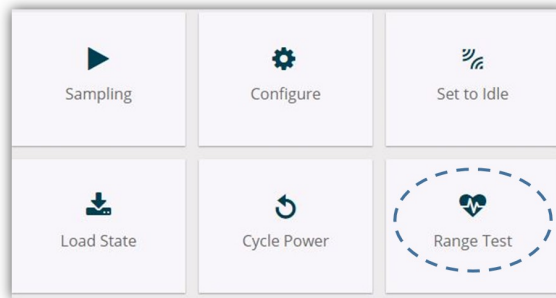

Figure 31 - Range Test Menu

2. RSSI is a measure of signal strength between the node and the base station. A higher RSSI value (closer to zero), will result in better node to base station communication. Reliable communication can be achieved with a signal strength greater than -75 dBm, in the absence of radio frequency interference. Position the node and gateway antennas where the best RSSI value is observed.

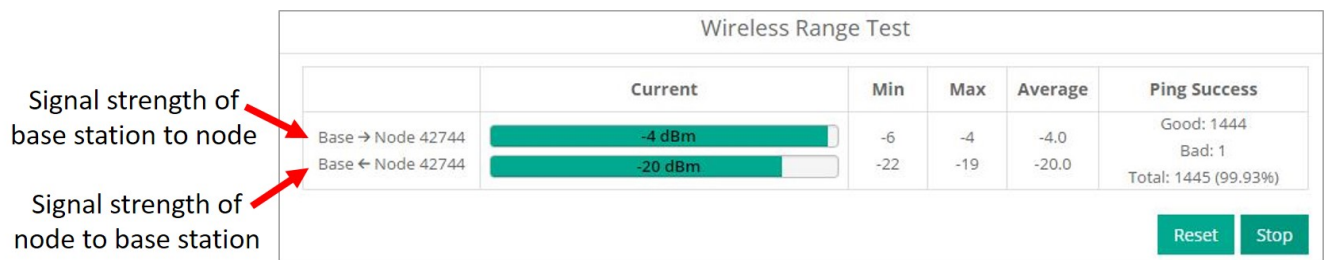
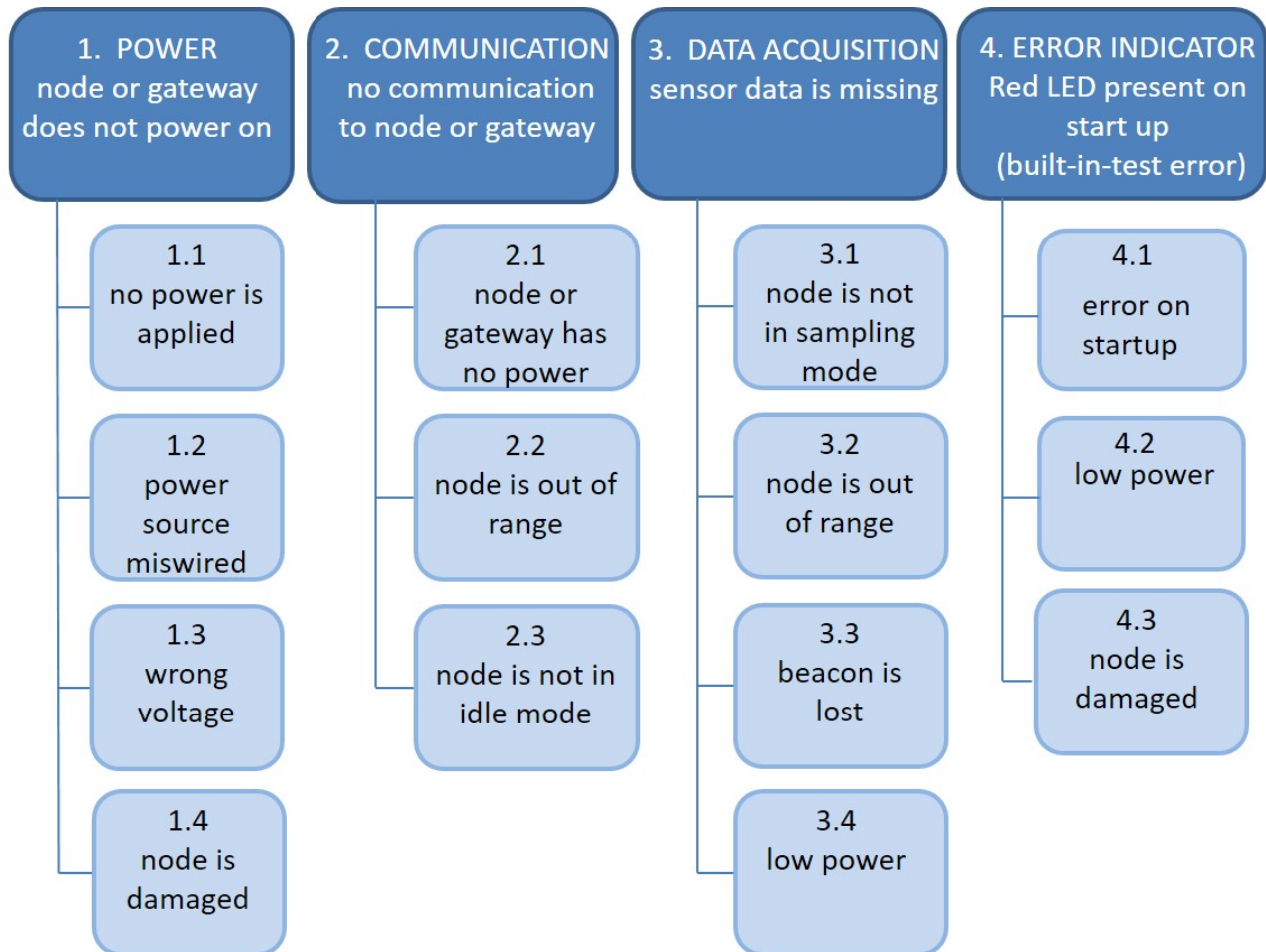

Figure 32 - Range Test Statistics

8. Troubleshooting

8.1 Troubleshooting Guide



| | Possible cause and recommended solution |
|--|---|
| 1. POWER gateway or node does not power on | 1.1 no power is applied The status indicator LED on the device may be off. Apply power to device, and the status indicator LED should illuminate. |
| | 1.2 power source miswired Verify the device power source is connected correctly and power is applied. |
| | 1.3 wrong voltage Using a power supply that is outside of the device operating range could result in permanent damage to the device or cause it to not work properly. |
| | 1.4 node is damaged If all power settings and connections have been verified, and the node is still unresponsive, contact LORD Sensing Technical Support (See Technical Support on page 45). |
| 2. COMMUNICATION no communication to the gateway or node | 2.1 node or gateway has no power Verify the node and gateway have power applied and that applicable power switches are on. Power is indicated on both devices by a status indicator LED. |
| | 2.2 node is out of range Perform a bench test with the node in close proximity to the gateway to verify they are operational. For range test and installation recommendations See Range Test on page 34 . |
| | 2.3 node is not in idle mode Perform Set to Idle command from software. Let it run for up to 30 seconds to see if the node can be reached. |
| 3. DATA ACQUISITION sensor data is missing | 3.1 node is not in sampling mode Observe the diagnostic data for “node state” to see if the node is in IDLE, SLEEP, or RUN mode. |
| | 3.2 node is out of range Observe RSSI in the diagnostic data to assure signal strength is adequate. Increase transmit power to maximum or move gateways closer if out of range. |
| | 3.3 beacon is lost during synchronized sampling The node will stop sampling if it cannot find the beacon. Assure the beacon is enabled on the WSDA gateway, and the node is in good communication range. |
| | 3.4 low power The node will stop sampling if it detects low battery. Observe the diagnostic for a low battery flag. |
| 4. | 4.1 error on startup Power down node for 10 seconds and repower. |

| | Possible cause and recommended solution |
|---|--|
| ERROR INDICATOR Red LED present on start up | 4.2 low power Replace battery or power source and repower node. |
| | 4.3 node is damaged If Red LED persists after all power settings and connections have been verified, there is damage to the node Contact LORD Sensing Technical Support for assistance (see Technical Support on page 45). |

8.2 Updating Node Firmware

Under the recommendation of LORD Sensing Technical Support Engineers, nodes can be upgraded to the latest available firmware to take advantage of new features or correct operating issues. SensorConnect version 5.0.0 or greater can be used to update any mXRS or LXRS node or gateway firmware to the most current version. Updates are found on the LORD Sensing website. [See Technical Support on page 45](#) for contact and website information.

1. Download the Firmware Upgrade file from the LORD Sensing website.
2. Once downloaded, extract the contents of the .zip file into a folder on the computer. Verify there is a file with a .zhex extension.
3. Launch SensorConnect, and establish communication between the node and gateway as normal.
4. Select the Node address > Upgrade Firmware > select Browse > select the Firmware Upgrade file > Start Upgrade

8.3 Repair and Calibration



General Instructions

In order to return any LORD Sensing product, you must contact LORD Sensing Sales or Technical Support to obtain a Return Merchandise Authorization number (RMA). All returned merchandise must be in the original packaging including manuals, accessories, cables, etc. with the RMA number clearly printed on the outside of the package. Removable batteries should be removed and packaged in separate protective wrapping. Please provide the LORD Sensing model number and serial number as well as your name, organization, shipping address, telephone number, and email. Normal turn-around for RMA items is seven days from receipt of item by LORD Sensing.



Warranty Repairs

LORD Sensing warrants its products to be free from defective material and workmanship for a period of one (1) year from the original date of purchase. LORD Sensing will repair or replace, at its discretion, a defective product if returned to LORD Sensing within the warranty period. This warranty does not extend to any LORD Sensing products which have been subject to misuse, alteration, neglect, accident, incorrect wiring, mis-programming, or use in violation of operating instructions furnished by us. It also does not extend to any units altered or repaired for warranty defect by anyone other than LORD Sensing.



Non-Warranty Repairs

All non-warranty repairs/replacements include a minimum charge. If the repair/replacement charge exceeds the minimum, LORD Sensing will contact the customer for approval to proceed beyond the minimum with the repair/replacement.

9. Specifications

9.1 Physical Specifications

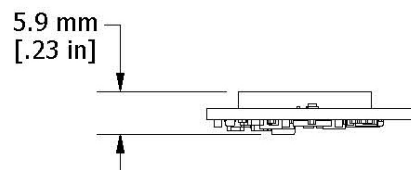
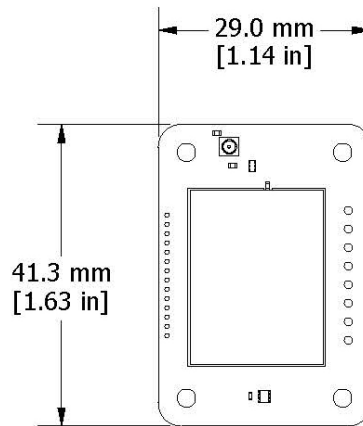

Dimensions: 41.3 mm x 29 mm x 5.9 mm
Weight: 7 grams

9.2 Operating Specifications

| Parameter | Specifications |
|--|--|
| General | |
| Sensor input channels | Thermocouple, RTD, or Thermistor input, 1 channel |
| Integrated sensors | Temperature CJC, 1 channel |
| Digital filter | Adjustable low pass filter with 3db frequency as low as 2.3 Hz and up to 120 db 50/60 Hz rejection |
| Thermocouple Input | |
| Measurement range | -210° C to 1820° C (depending on thermocouple type) |
| Accuracy | ±0.25° C (20 to 70° C node temperature) ±0.5° C (-40 to 105° C node temperature) |
| Resolution | 0.1° C |
| Compatible types | J, K, N, R, S, T, E and B |
| RTD Input | |
| Measurement range | -200° C to 850° C |
| Accuracy | ±0.5° C (depending on RTD accuracy) |
| Resolution | 0.01° C |
| Compatible types | PT-10, PT-50, PT-100, PT-200, PT-500, PT-1000 |
| Thermistor Input | |
| Measurement range | -40° C to 150° C (depending on Thermistor type) |
| Accuracy | ±3° C (depending on Thermistor accuracy) |
| Resolution | 0.02° C |
| Compatible types | 44004, 44033, 44005, 44030, 44006, 44031, 44007, 44034, 44008, 44032, YSI-400 |
| Integrated Temperature Cold Junction Compensation (CJC) Channel | |
| Compensation range | -40° C to 105° C (0° C to 105° C for type B Thermocouples) |
| Accuracy | ±0.13° C (20° C to 70° C), ±0.25° C (-40° C to 105° C) |
| Resolution | 0.02° C |
| Sampling | |
| Sampling modes | Continuous and event triggered |
| Output options | Temperature, mV, Resistance or custom |
| Sampling rates | 1 channel: up to 128 Hz |
| Sample rate stability | ±5 ppm |
| Network capacity | Up to 128 nodes per RF channel (bandwidth calculator: www.microstrain.com/configure-your-system) |
| Node synchronization | ±50 µsec |
| Data storage capacity | 16 M Bytes (up to 8,000,000 data points) |
| Operating Parameters | |
| Wireless communication range | Outdoor/line-of-sight: 2 km (ideal), 800 m (typical) Onboard antenna: 1 km (ideal), 400 (typical) Indoor/obstructions: 50 m (typical) |
| Radio frequency (RF) transceiver carrier | License-free 2.405 to 2.480 GHz (16 channels) |
| RF transmit power | User-set 0 dBm to 20 dBm. restricted regionally |
| Operating temperature | -40° C to +105° C |
| ESD | 4 kV |
| Physical Specifications | |
| Dimensions | 41.3 mm x 29 mm x 5.9 mm |
| Interface | Solder or screw-down terminal available |
| Weight | 7 grams |

| Parameter | Specifications |
|---------------------------------|---|
| Integration | |
| Compatible gateways | All WSDA gateways |
| Software | SensorCloud, SensorConnect, Windows 7, 8 & 10 compatible |
| Software development kit | http://www.microstrain.com/software/mscl |
| Regulatory compliance | FCC (USA), IC (Canada), CE (European Union), JET (Japan) |

10. Safety Information

This section provides a summary of general safety precautions that must be understood and applied during operation and maintenance of components in the LORD Sensing Wireless Sensor Network.

10.1 Powering the Node

The power source is an external supply within 3.3 - 30 V dc.

10.2 ESD Sensitivity

The TC-Link-200-OEM is intended to be integrated into an application appropriate housing to protect it from environmental elements, impact, and electrostatic discharge (ESD), which can disrupt operation or damage PCB.

CAUTION

The TC-Link-200-OEM is susceptible to damage and/or disruption of normal operation from Electrostatic Discharge (ESD). ESD may cause the device to reset, which may require user intervention to continue data acquisition.

10.3 Disposal and Recycling

WARNING

CAUTION

NOTICE



The TC-Link[®]-200-OEM contains printed circuit boards and electronic components. These items are known to contain toxic chemicals and heavy metals that are harmful to humans health and the environment. Disposal is subject to federal and local laws. Do not discard the device in the trash. Follow proper electronic and battery waste disposal protocol, as dictated by federal and local authorities. Some states have programs for extracting reusable parts for recycling.

10.4 Radio Specifications

The TC-Link-200-OEM employs a 2.4GHz IEEE 802.15.4-compliant radio transceiver for wireless communication. The radio is a direct-sequence spread spectrum radio and can be configured to operate on 16 separate frequencies ranging from 2.405 GHz to 2.480 GHz. Following the 802.15.4 standard, these frequencies are aliased as channels 11 through 26. For all newly manufactured nodes, the default setting is 2.425 GHz (channel 15).

TC-Link-200-OEM
FCC ID: XJQMSLINK0011
IC ID: 8505A-MSLINK00 11

This device complies with Part 15 of the United States FCC Rules, and Industry Canada's license-exempt RSSs. Operation is subject to the following two conditions: 1) This device may not cause interference, and 2) This device must accept any interference, including interference that may cause undesired operation of the device. Changes or modifications, including antenna changes not expressly approved by LORD Corporation could void the user's authority to operate the equipment.

Cet appareil est conforme à la Partie 15 des Règles de la FCC des États-Unis et aux RSSS exempts de licence d'Industrie Canada. Le fonctionnement est soumis aux deux conditions suivantes: 1) Cet appareil ne doit pas causer d'interférences et 2) Cet appareil doit accepter toute interférence, y compris les interférences pouvant entraîner un fonctionnement indésirable de l'appareil. Les changements ou modifications, y compris les changements d'antenne non expressément approuvés par LORD Corporation, pourraient annuler l'autorisation de l'utilisateur d'utiliser l'équipement.

11. References

Technical Support

There are many resources for product support found on the LORD Sensing website, including technical notes, FAQs, and product manuals.

<http://www.microstrain.com/support/documentation>

For further assistance our technical support engineers are available to help with technical and applications questions.

Technical Support

sensing_support@LORD.com

Phone: 802-862-6629

Fax: 802-863-4093

9:00 AM to 5:00 PM (Eastern Time US & Canada)

SKYPE: microstrain.wireless.support

Live Chat is available from the website during business hours:

9:00 AM to 5:00 PM (Eastern Time US & Canada)

Product Ordering

Products can be ordered directly from the LORD Sensing website by navigating to the product page and using the Buy feature.

<http://www.microstrain.com/wireless>

For further assistance, our sales team is available to help with product selection, ordering options, and questions.

Sales Support

sensing_sales@LORD.com

Phone: 802-862-6629

Fax: 802-863-4093

9:00 AM to 5:00 PM (Eastern Time US & Canada)

11.1 Related Documents

Many references are available on the LORD Sensing website including product user manuals, technical notes, and quick start guides. These documents are continuously updated, and new applications are added. They may provide more accurate information than printed or file copies.

| Document | Where to find it |
|-------------------------------------|---|
| Online Wireless Network Calculator | http://sensorcloud.com/?onlyCalc=true |
| Product Datasheets | http://www.microstrain.com/wireless/sensors |
| Product Manuals and Technical Notes | http://www.microstrain.com/support/documentation |
| Product Application Notes | http://www.microstrain.com/applications |
| NIST Calibration Procedures | http://www.nist.gov/calibrations/ |
| ASTM Testing Procedures | http://www.astm.org/Standard/standards-and-publications.html |

Table 5 - Related Documents

11. Appendix

11.2 Accuracy and Resolution

11.2.1 Thermocouple

| Stat | B | E | J | K | N | R | S | T | Total |
|----------------------|-----------|-----------|-----------|-----------|-----------|-----------|-----------|-----------|-----------|
| Mean Resolution (°C) | 0.011409 | 0.005539 | 0.007141 | 0.010171 | 0.011452 | 0.016759 | 0.009442 | 0.004456 | 0.009546 |
| Max Resolution (°C) | 0.041074 | 0.015529 | 0.061325 | 0.025411 | 0.039155 | 0.052701 | 0.024682 | 0.012361 | 0.061325 |
| Mean Error (°C) | ±0.036163 | ±0.117094 | ±0.126652 | ±0.141865 | ±0.111679 | ±0.088354 | ±0.098357 | ±0.128579 | ±0.106093 |
| Max Error (°C) | ±0.251826 | ±0.383118 | ±0.393911 | ±0.390540 | ±0.471668 | ±0.408659 | ±0.382590 | ±0.440225 | ±0.471668 |

Table 6 - Thermocouple Accuracy and Resolution

11.2.2 Resistance Thermometers

| Stat | PT-10 | PT-100 | PT-1000 | PT-200 | PT-50 | PT-500 | Total |
|----------------------|-----------|-----------|-----------|-----------|-----------|-----------|-----------|
| Mean Resolution (°C) | 0.002853 | 0.004892 | 0.003312 | 0.005259 | 0.004710 | 0.005099 | 0.004354 |
| Max Resolution (°C) | 0.003477 | 0.006349 | 0.006820 | 0.007283 | 0.005906 | 0.008374 | 0.008374 |
| Mean Error (°C) | ±0.286750 | ±0.317604 | ±0.247945 | ±0.345573 | ±0.475224 | ±0.350322 | ±0.337236 |
| Max Error (°C) | ±0.381720 | ±0.439894 | ±0.469876 | ±0.499193 | ±0.622852 | ±0.568495 | ±0.622852 |

Table 7 - Resistance Thermometer Accuracy and Resolution

12. Glossary

These terms are in common use throughout the manual:

A/D Value: the digital representation of the analog voltages in an analog-to-digital (A/D) conversion. The accuracy of the conversion is dependent on the resolution of the system electronics; higher resolution produces a more accurate conversion. Also referred to as "bits".

Base Station: The base station is the transceiver that attaches to the host computer and provides communication between the software and the node(s). It is also referred to as a gateway.

Burst Sampling: a mode of operation in which the node is sampled for a fixed window of time (burst) and then repeats that window at set intervals. The burst duration and time between bursts is configurable. Also referred to as periodic burst sampling.

Calibration: to standardize a measurement by determining the deviation standard and applying a correction (or calibration) factor

Configuration: a general term applied to the node indicating how it is set up for data acquisition. It includes settings such as sampling mode/rate, number of active channels, channel measurement settings, offsets, hardware gain, and calibration values.

Continuous Sampling: a mode of operation in which the node is sampled continuously until stopped or sampled continuously for a fixed amount of time

Coordinated Universal Time (UTC): the primary time standard for world clocks and time. It is similar to Greenwich Mean Time (GMT).

Cycle Power: a command transmitted to the node to reboot it either through a hardware or software switch

Data Acquisition: the process of collecting data from sensors and other devices

Data Logging: the process of saving acquired data to the system memory, either locally on the node or remotely on the host computer

DHCP (network): Dynamic Host Configuration Protocol is the standardized networking protocol used on Internet Protocol (IP) networks, which automatically configures devices that are attached to it by assigning and configuring the device IP address.

EMI: Electromagnetic Interference is an inductive or radiated disturbance that can create signal degradation on electrical signals, including loss of data.

ESD: Electrostatic Discharge is the sudden flow of electricity that can occur between two charged objects of different potential that come in contact or in close proximity of each other. Static electricity is a common source of ESD.

Event-Based Sampling: a mode of operation in which the node sampling is started when a sensor measurement value (threshold) is achieved

Firmware: the code that is programmed onto a microcontroller or similar device in an embedded system. It includes device operation commands, conditions, memory allocation, and many other tasks.

Gateway: The gateway is a transceiver that attaches to the host computer and provides communication between the software and the node(s). It is also known as a base station.

Host (computer): The host computer is the computer that orchestrates command and control of the attached devices or networks.

LED: Light Emitting Diode is an indicator light that is used in electronic equipment.

LOS (Line of Sight): is used in radio communications to describe the ideal condition between transmitting and receiving antennas in a radio network. As stated it means the antennae are in view of each other with no obstructions.

LXRS: Lossless Extended Range Synchronized is the proprietary LORD Sensing data communications protocol used in the wireless sensor network.

Node: The node is the wireless transceiver to which the sensor (s) is connected, providing communication with the gateway. The G-Link[®]-LXRS[®], V-Link[®]-LXRS[®], and SG-Link[®]-LXRS[®] are examples of nodes manufactured by LORD MicroStrain[®].

Node Tester Board: The node tester board is a device designed by LORD MicroStrain[®] that can be plugged into nodes to test their functionality.

Offset: When describing a mathematically-linear relationship, the offset is the value where the line that represents the relationship in a graph crosses the y -axis. The equation of a straight line is: $y = mx + b$, where x is the x -axis coordinate, y is the y -axis coordinate, m is the slope and b is the offset.

Oversampling: In signal processing, oversampling is a technique used to achieve increased signal resolution and better noise immunity by recording readings at a higher frequency than the output of the device being measured. In analog-to-digital conversion, the higher the oversampling rate, the better the recreated analog signal.

Packet: unit of sampled data

Periodic Burst Sampling: a mode of operation in which the node is sampled for a fixed window of time (burst) and then repeats that window at set intervals. The burst duration and time between bursts is configurable. Also referred to as burst sampling.

Ping: a byte transmitted by the gateway to the node. The node responds by echoing the byte, indicating communication exists between the node and gateway.

Range Test: a continuous string of pings used to validate communication between the gateway and the node over distance and obstruction

Real Time Clock (RTC): a computer clock that keeps track of the current time

RFI: Radio Frequency Interference is a disturbance in an electrical circuit due to electromagnetic induction or radiation.

RSSI: Received Signal Strength Indication is a measurement of the transmission power in a radio signal. It is measured in decibels with reference to 1 milliWatt (dBm).

RS232: a serial data communications protocol

Sensor: a device that physically or chemically reacts to environmental forces and conditions, producing a predictable electrical signal

Sleep: a command transmitted to the node to put it into sleep configuration

Sampling: the process of taking measurements from a sensor or device

Sampling Mode: the type of sampling that is being utilized, such as event-triggered, continuous, or periodic. The nodes have several sampling modes that employ these types of sampling.

Sampling Rate: the frequency of sampling

Slope: When describing a mathematically linear relationship, the slope is the steepness of the line that represents that relationship on a graph. The equation of a straight line is: $y = mx + b$, where x is the x-axis coordinate, y is the y-axis coordinate, m is the slope, and b is the offset.

Streaming: Streaming is a sampling mode in which all active channels (and the sensors attached to them) are measured, and the acquired data is transmitted to the gateway and software. The data is not written to non-volatile memory during streaming. Streaming can either be finite (have a user defined start and end time) or continuous (continued until the power is cycled on the node).

Synchronized Sampling: a sampling mode that automatically coordinates all incoming node data to a particular gateway. This mode is designed to ensure data arrival and sequence.

Transmission rate: the number of data packets per transmission window, measured in seconds. Depending on the sampling mode and settings it will be between 1 and 64 packets/second.

Transmission window: the time allowed for one data transmission at the automatically determined transmission rate

USB: Universal Serial Bus is a serial data communications protocol

WSN: Wireless Sensor Network describes a distribution of sensors and data acquisition equipment that autonomously monitors environmental characteristics, such as temperature, pressure, and strain.