

3DM[®]-GX5-25

Attitude and Heading Reference System (AHRS)

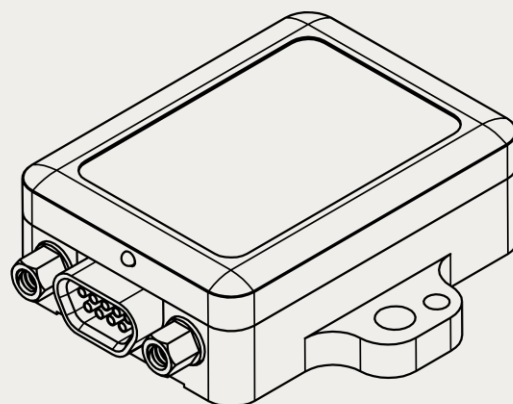



MicroStrain® Sensing Systems
459 Hurricane Lane
Suite 102
Williston, VT 05495
United States of America

Phone: 802-862-6629

www.microstrain.com
sensing_support@LORD.com
sensing_sales@LORD.com

Copyright © 2017 LORD Corporation

3DM®, 3DM-DH®, 3DM-DH3®, 3DM-GX2®, Ask Us How™, DEMOD-DC®, DVRT®, EmbedSense®, FAS-A®, G-Link®, Little Sensors, Big Ideas.®, LORD Microstrain®, Live Connect™, LXRS®, MathEngine®, MicroStrain®, MXRS®, Node Commander®, SensorCloud™, SG-Link®, Strain Wizard®, TC-Link®, V-Link®, Wireless Simplicity, Hardwired Reliability™, and WSDA® are trademarks of LORD Corporation.

Document 8500-0012 Revision D

Subject to change without notice.

Table of Contents

1. System Family Overview	6
2. Sensor Overview	7
2.1 Components.....	8
2.2 Interface and Indicators.....	9
3. Basic Setup and Operations	10
3.1 Software Installation.....	11
3.2 System Connections.....	12
3.3 Software Interface.....	13
3.3.1 <i>Interactive Help Menu</i>	13
3.4 Sensor Communication.....	14
3.5 Satellite Link.....	15
3.6 Sensor Settings.....	15
3.6.1 <i>Saving Configurations</i>	16
3.7 Data Monitoring and Recording.....	17
3.8 View Recorded Data.....	18
4. Sensor Measurements	21
4.1 Direct Sensor Measurements (IMU Outputs).....	22
4.2 Computed Outputs.....	24
4.3 Sensor Reference Frames.....	26
4.3.1 <i>Geodetic Frame</i>	26
4.3.2 <i>North East Down (NED) Frame</i>	27
4.3.3 <i>Sensor Frame</i>	28
4.3.4 <i>Platform Frame</i>	29
5. Performance Optimization	31
5.1 Gyroscope Bias.....	31

5.2	Tare Mounting Pitch-Roll.....	32
5.3	Magnetometer Auto Calibration.....	33
5.3.1	<i>Enable</i>	33
5.3.2	<i>Capture</i>	34
5.4	Magnetometer Manual Calibration.....	35
5.5	Estimation Filter Aiding.....	38
5.6	Heading Aiding Settings.....	39
5.6.1	<i>Bias Convergence</i>	40
5.7	Adaptive Anomaly Rejection.....	40
5.7.1	<i>Gravity Adaptive</i>	40
5.7.2	<i>Mag Adaptive</i>	41
5.8	Communications Bandwidth.....	42
5.9	Platform Frame Transformation.....	42
5.10	Estimation Filter Operation.....	42
5.11	Estimation Filter Convergence.....	43
5.11.1	<i>Initial Convergence</i>	43
5.11.2	<i>Output Uncertainty</i>	43
5.12	Vibration Isolation.....	44
5.13	IMU Sensor Calibration.....	44
5.14	Temperature Compensation.....	44
5.15	Import and Export Settings.....	44
6.	Sensor Installation.....	46
6.1	Sensor Mounting.....	46
7.	OEM System Integration.....	47
7.1	Data Communications Protocol (DCP).....	47
7.1.1	<i>Packet Builder</i>	48
7.1.2	<i>Sensor Direct Mode</i>	48

7.2	Sensor Wiring.....	50
7.3	Sampling on Start-up.....	51
7.4	Connecting to a Datalogger.....	52
7.5	Using Wireless Adapters.....	52
8.	Troubleshooting.....	53
8.1	Troubleshooting Guide.....	53
8.2	Repair and Calibration.....	57
8.3	Maintenance.....	57
8.4	Technical Support.....	58
9.	Parts and Configurations.....	59
9.1	Standard Configurations.....	59
9.2	Accessories.....	61
9.3	Sales Support.....	61
10.	Specifications.....	62
11.	Reference Diagrams.....	64
11.1	Sensor Dimensions and Origin.....	64
11.2	Power Supply Specifications.....	65
11.3	Communication and Power Cables.....	66
12.	Reference Documents.....	68
13.	Glossary.....	69

1. System Family Overview

The **LORD Sensing** 3DM-GX5 family of industrial-grade inertial sensors provides a wide range of triaxial inertial measurements and computed attitude and navigation solutions.

In all models, the Inertial Measurement Unit (IMU) includes direct measurement of acceleration and angular rate, and some also offer atmospheric pressure readings. In models that include a Kalman Filter, sensor measurements are processed through an Extended Kalman Filter (EKF) to produce highly accurate computed outputs. The 3DM-GX5 features include extremely stable and low-noise gyros, a new accelerometer with noise densities as low as 25 $\mu\text{g}/\sqrt{\text{Hz}}$, and a multi-constellation GNSS receiver. The M7 and M4 dual Cortex processors run a new Auto-Adaptive EKF. The Kalman filter enables compensation for magnetic and linear acceleration anomalies as applicable to the model. It also provides sensor bias tracking, auto-zero update options (ZUPT), and user adjustable sensor noise factors. All sensors are fully temperature-compensated and calibrated over the full operating temperature range.

The use of Micro-Electro-Mechanical System (MEMS) technology allows for small, lightweight devices. Sensors are integrated into customer systems using serial communication protocols such as RS422, RS232 and USB. The LORD Sensing MIP Monitor software can be used for device configuration, real time measurement monitoring, and data recording. The LORD Sensing MIP Data Communications Protocol (DCP) that is used to communicate with LORD Sensing inertial sensors is also available for users who want to develop customized software solutions. Because of the unified set of commands across the sensor family, it is easy to migrate code from one inertial sensor to another.

Common applications of LORD Sensing inertial sensor products include vehicle health monitoring, platform stabilization, down-hole and drilling operations, and inertial navigation systems such as unmanned air and ground vehicles and personal navigation systems.



2. Sensor Overview

The 3DM - GX5 - 25 is a high- performance, industrial- grade Attitude and Heading Reference System (AHRS) that utilizes micro inertial sensors for use in a wide range of industrial-grade applications, such as unmanned vehicle navigation, platform stabilization, and vehicle health monitoring.

The 3DM- GX5- 25 combines the strengths of an integrated multi-axis gyroscope, accelerometer, and magnetometer, in combination with temperature and pressure readings to provide highly accurate attitude (including heading), and inertial measurements. All sensor measurements are temperature-compensated and are mathematically aligned to an orthogonal coordinate system. The combination of sensors, environmental compensation, and dual on- board processing with an Auto- Adaptive Extended Kalman Filter (EKF) allows the 3DM-GX5-25 to perform well in a wide variety of applications that require low noise, drift, gain, and offset errors.

The 3DM - GX5 - 25 communicates through a serial connection and is monitored by a host computer. Sensor measurements and computed outputs can be viewed and recorded with the LORD Sensing MIP Monitor software that is available as a free download from the LORD Sensing website. Alternatively, users can write custom software with the LORD Sensing open source data communication protocol. The data is time-aligned and available by either polling or continuous stream.



Figure 1 -3DM-GX5-25 Sensor

2.1 Components

The 3DM- GX5- 25 Inertial Sensor can be purchased by itself or as part of a Connectivity Kit . All software, drivers, and links to detailed documentation are included with the sensor purchase. For a complete list of available configurations, accessories, additional system products, and ordering information, [see Parts and Configurations on page 59](#) .



Item	Description	Model	LORD Sensing Part Number
Included with Sensor Purchase			
A	3DM-GX5-25 Inertial Sensor	AHRS 8G, 300 DPS*	6253-4220
	MIP Monitor Software Suite http://www.microstrain.com/software		
	* For additional options available see Specifications on page 62		
USB Connectivity Kit			
B	USB Communication Cable	--	6212-3004
RS232 Connectivity Kit			
C	RS232 Communication Cable	--	6212-3001
	RS232 Power Supply and Plug Adapters		

Table 1 - 3DM-GX5-25 Components

2.2 Interface and Indicators

The 3DM-GX5-25 sensor interface includes a communications and power input connector. The sensor is installed using the mounting and alignment holes as needed (*see Sensor Mounting on page 1*).

The indicators on the 3DM-GX5-25 include a device status indicator and the device information label. The table below describes the basic status indicator behavior. The device information label includes the sensor frame diagram (axis orientation), which will be critical during device installation (*see Sensor Frame on page 28*).

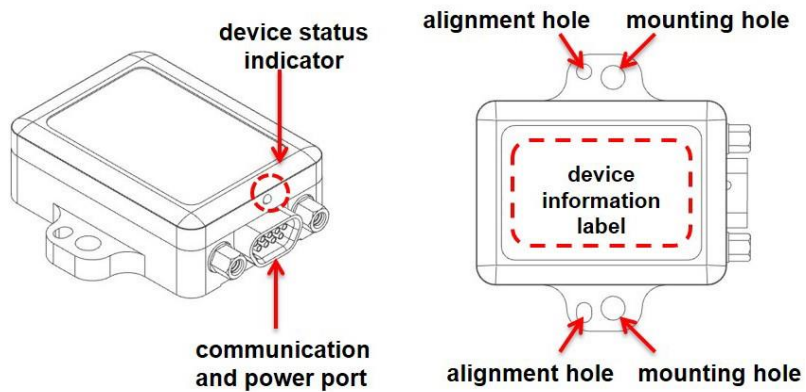

Indicator	Behavior	Device Status
device status indicator	OFF	no power applied
	rapid flash	streaming data
	slow pulse	idle mode, awaiting commands

Figure 2 -Sensor Indicator Behaviors

3. Basic Setup and Operations

NOTICE

Do not put the 3DM- GX5- 25 in contact with, or in close proximity to, magnets. Magnets may disrupt operation and cause magnetization of internal components, which can affect magnetometer performance. If magnetization is suspected, use a degaussing tool to demagnetize.

To acquire sensor measurements and computed outputs, the 3DM- GX5- 25 uses a host computer, an RS232 or USB communications port, and applicable software. The LORD Sensing MIP Monitor software is provided with the system and includes all functions needed for sensor configuration and data acquisition. Users may also utilize the LORD Sensing MIP Data Communications Protocol (DCP) to write custom software applications with expanded or specific feature sets needed for the application. MIP Monitor includes a message building tool that can be used to streamline this process. For more information, [see OEM System Integration on page 47](#).

In this section, hardware and software setup is described, including an overview of the MIP Monitor software menus required to configure a sensor and begin data acquisition. This is not a complete demonstration of all system or software features and capabilities.

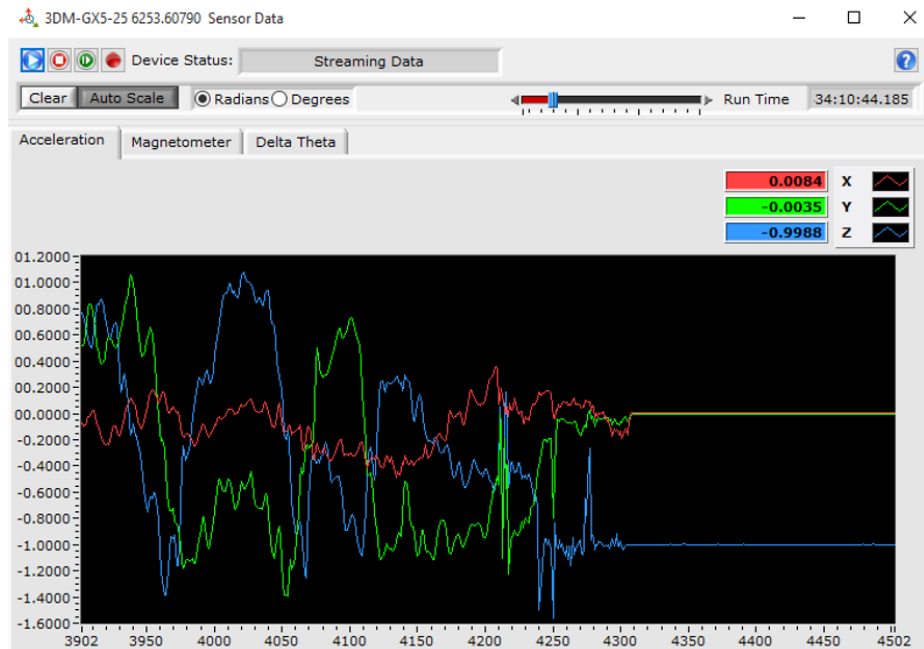

Figure 3 -Viewing Sensor Data with MIP Monitor

3.1 Software Installation

NOTE

The MIP Monitor Software Suite includes hardware drivers required for 3DM-GX5-25 sensor operation. Sensors will not be recognized without these drivers installed.

To Install the MIP Monitor software on the host computer, complete the following steps:

1. Launch the MIP Monitor software installation menu at:
<https://www.microstrain.com/software>.
2. Download and open the MIP Monitor .zip file.
3. Run the **setup.exe** file, and follow the on-screen prompts to completion.
4. Download and open the Inertial Drivers zip folder to install the hardware drivers required for operating the sensor.
5. Run the .msi file, and follow the on-screen prompts to completion.
6. Download and open the Iron Calibration .zip file to facilitate magnetometer field calibration.
7. Run the **setup.exe** file, and follow the on-screen prompts to completion. If prompted, reboot the computer when complete.

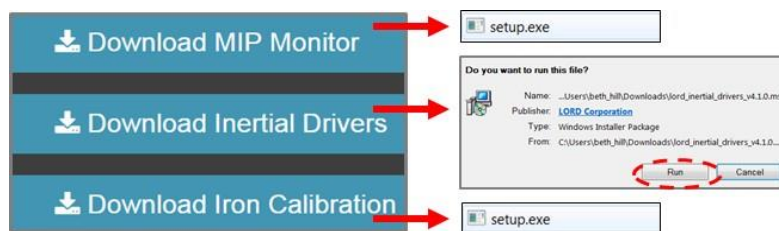

Figure 4 -Software Installation Menu

3.2 System Connections

CAUTION

Power is applied to the sensor through a host computer USB port or an external power supply, such as the one provided in the RS232 connectivitykit. Use only power supplies within the operating range of the sensor, or damage or injury could result. Once power is applied the sensor is on and active (*see Specifications on page 62*).

To acquire sensor data the following components are needed: 3DM-GX5-25 sensor, communication cable, power cable (as applicable for RS232 communications) , and a host computer with LORD Sensing MIP Monitor installed.

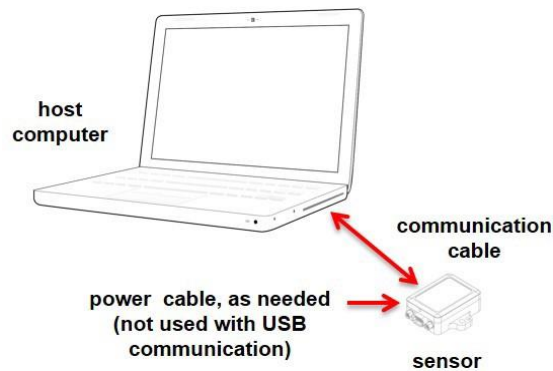

Figure 5 -System Connections

3.3 Software Interface

The MIP Monitor software includes a main window with system information and menus, a device settings window, and several data monitoring windows.

The main window provides an overview of connected devices. Devices are selected by clicking on them. A device menu is available by right-clicking on the device name and includes the most used items from the header row menus. The header row menu includes selections for data sampling, recording, device settings, opening windows, selecting which open window to view, and advanced features such as selecting the communications mode. The icon toolbar includes buttons for Help Menu access, where all related documentation is available in Web Resources, device refresh, and data sampling and recording.

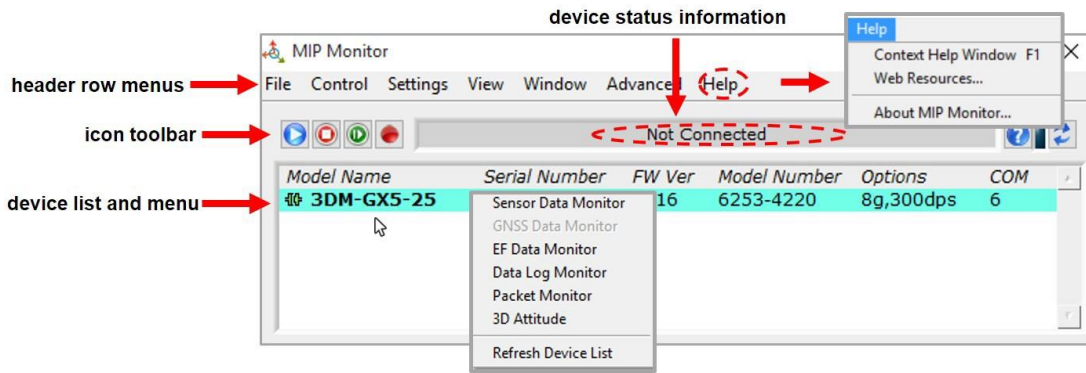

Figure 6 - Main Window Display

3.3.1 Interactive Help Menu

MIP Monitor also includes a mouse-over feature that provides explanations of the information and settings. This feature is enabled by selecting the question mark icon or Help button in any window.

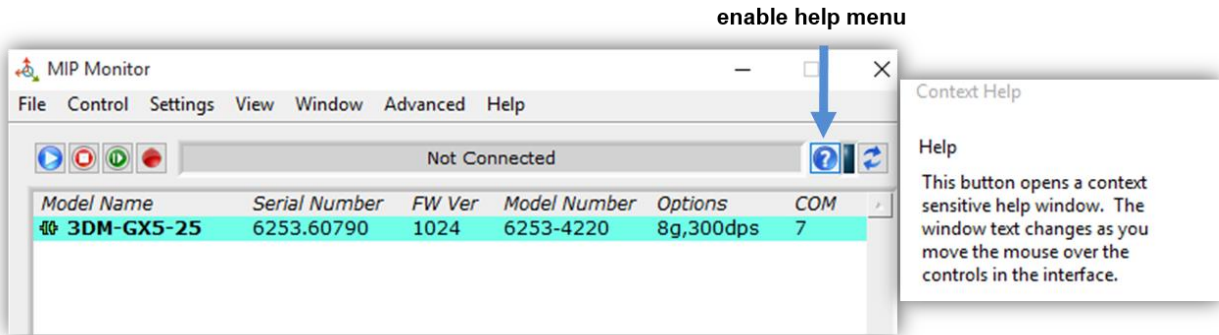

Figure 7 - Context Sensitive Help Menu

3.4 Sensor Communication

Once power has been applied to the sensor, it is functional. The sensor selects the appropriate serial communication (USB or RS232) on power-up based on which cable is connected. If the hardware drivers have been installed, communication can be established using the MIP Monitor software interface.

1. Verify the sensor device status indicator is on.
2. Open the MIP Monitor software.
3. The sensor should appear in the device list automatically when the software is running. The list includes the device information and communication port assignment. If the sensor is not automatically discovered, use the refresh button.

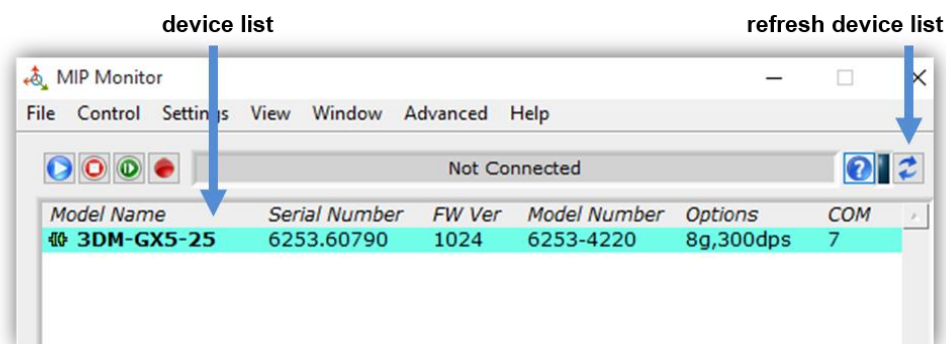

Figure 8 -Sensor Communication

NOTE

If data is not actively being exchanged between the sensor and host computer, the status message may display Not Connected. This indicates the port status, not the sensor availability. When commands are sent to the sensor, the software will automatically connect to it before sending the message.

3.5 Satellite Link

3.6 Sensor Settings

Device settings are stored in the sensor memory. Only the configuration options available for the sensor being used are displayed in the menus.

To enter the settings menu, either right-click on the sensor name highlighted in the main window, and then select Device Settings, or select Settings > Device from the main menu.

- Main menu tabs:** The main tabs divide the settings into functional groups for the available measurements. For the 3DM-GX5-25 these include calculated measurements (Estimation Filter) and direct inertial sensor measurements (IMU/AHRS).
- Message Format (first sub-menu tab):** Under each main menu tab there are additional sub-menu tabs, including the Message Format tab, which allows the user to select the measurement type to be displayed and recorded (b1) and the data rate in samples/second(b2).
- Measurement parameters:** Available sub-menu tabs depend on the selected main menu tab. They include the device configurable settings for each measurement.
- Scrolling:** used to navigate to additional sub-menus
- Help button:** Enable the context-sensitive help menu for more information ([see Interactive Help Menu on page 13](#)).

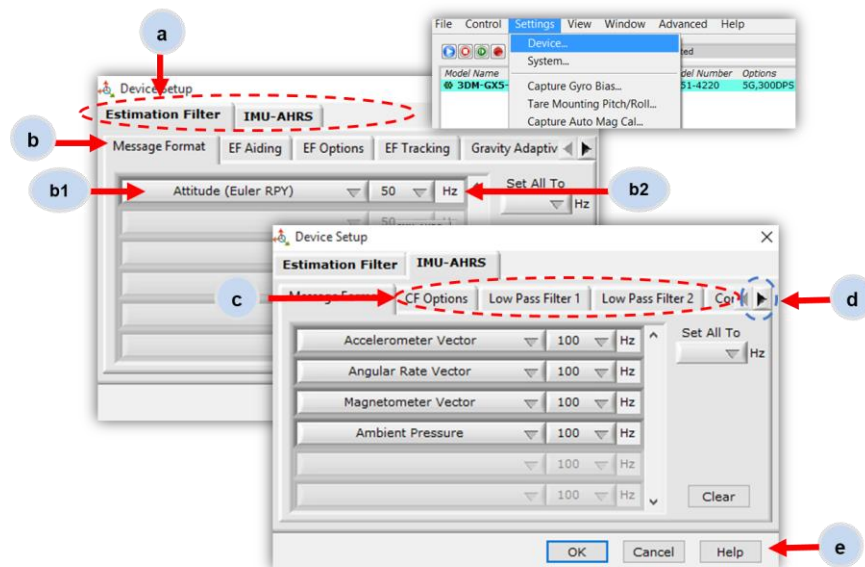

Figure 9 -Device Settings Menu

3.6.1 Saving Configurations

Sensor settings are saved temporarily by selecting the OK button in the Device Setup window after configuration, but they are lost when the device is powered off. To save current settings, so they are automatically restored the next time the device is powered on, select Settings > Save Current Settings.

First adjust the sensor settings to the desired values. Next select Settings > Save Current Settings from the main window (*Figure 10 - Save Sensor Settings*). The settings will now remain intact when the sensor is powered off and then on again.

To recall the last saved settings select Settings > Load Startup Settings. To revert the settings back to the factory defaults, select Settings > Load Default Settings.

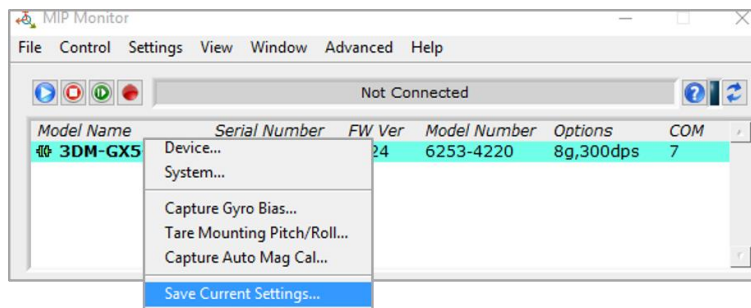
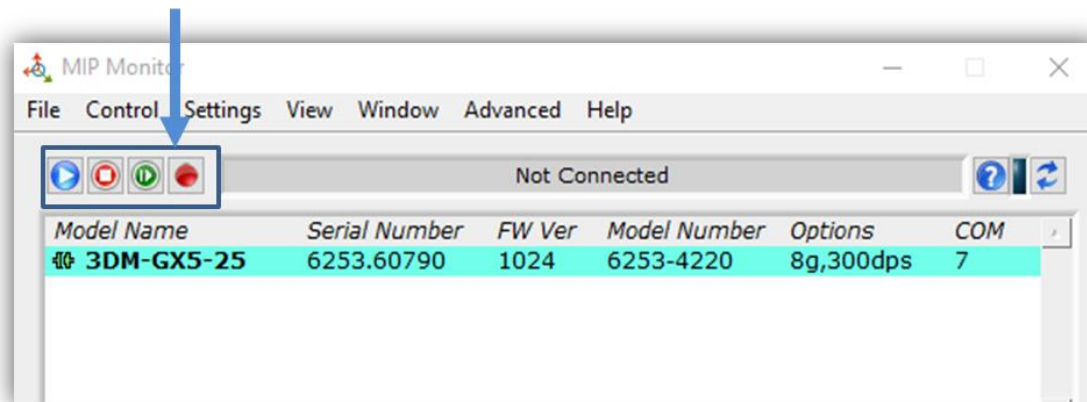

Figure 10 -Save Sensor Settings

3.7 Data Monitoring and Recording

Throughout the MIP Monitor views the same icons are used to control data streaming (sampling) and recording. These icons can be found in the MIP Monitor main window icon toolbar and in each data monitoring window. The same commands are also found in the main window Control menu.

sampling and recording controls (main window)



Icon	Command
	Run: start data streaming
	Stop: end data streaming
	Step: sample single set of data
	Record: start and stop data recording

Figure 11 -Main Window Controls

There are several data monitoring views available depending on what measurements are desired for monitoring and recording. Each view corresponds to one of the main categories in the Device Settings window. For example, the 3DM - GX5 - 25 includes Sensor Data Monitoring for the IMU/AHRS measurements and EF Monitoring for the Estimation Filter outputs. During viewing and recording only the outputs that are selected in the Message Format tab of the Device Settings menu are displayed and recorded ([see Sensor Settings on page 15](#)).

Data streaming must be started in order for data to be recorded, however it is not necessary to view it in a data monitoring window. Data monitoring is used primarily to confirm the system is operating correctly or to view the outputs in near real time. If sensor setup has already been confirmed, streaming and recording can be initiated from the main window.

Figure 12 - Data Streaming is an example of Sensor Data Monitoring, which displays the selected IMU/AHRS measurements. In data monitoring windows, no data will be displayed until data streaming is started, and no data will be recorded (even if it is being viewed) until data recording is initiated (armed). In the example below, the y- axis of the graph indicates data points, the x- axis is the measurement units, and there is a tab for each measurement.

1. Right- click on the device in the MIP Monitor software main window, and select Sensor Data Monitor.
2. Click the blue Start Streaming icon to start sampling.



Figure 12 -Data Streaming

3.8 View Recorded Data

Recorded data is stored in either Binary (.bin) or Comma Separated Values (.csv) format, depending on what was selected at the initiation of data recording. The files can be found in the

directory specified at that time or in the default directory on the host computer desktop.

CSV files can be viewed with Microsoft Excel, Quattro Pro, Open Office, or other CSV editors and spreadsheet programs.

Data recorded in Binary format requires a translation program utilizing the LORD Sensing MIP Data Communications Protocol (DCP) to make it user-readable.

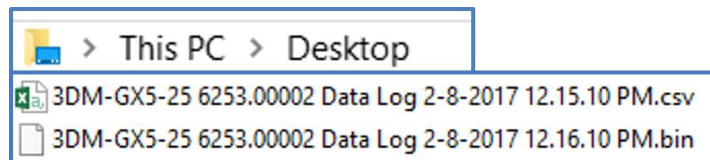

1. To record data, select the Arm Recording icon at any time.
2. Select the type of data file to generate: Binary or CSV. The CSV file is the most common and can be viewed and processed by data editors such as Microsoft Excel.
3. To save a settings file when creating a data file, check the box next to this option. This settings file is the same as selecting Export Settings from the Settings menu.

NOTE

If the data is recorded in Binary format it will require a translation program that utilizes the LORD Sensing MIP Data Communications Protocol (DCP) to make it user-readable.

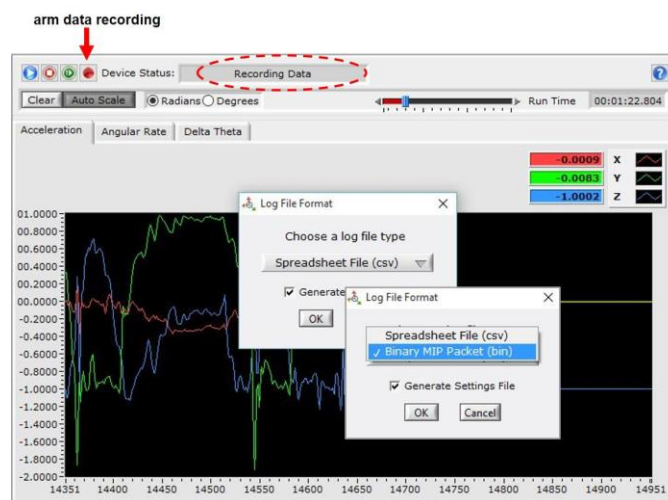

Figure 13 -Data Recording

4. To end recording press the Arm Recording button again, and select OK in the confirmation prompt window.
5. Select the Stop Streaming icon to end sampling.
6. Use the red "X" in the upper right of the sensor monitoring window to exit monitoring mode.

4. Sensor Measurements

The 3DM - GX5 - 25 block diagram (*Figure 14 - 3DM- GX5- 25 Block Diagram*) describes its primary hardware components and internal configuration. Integrated Micro-Electro-Mechanical System (MEMS) sensors within the 3DM- GX5 - 25 are collectively known as the Inertial Measurement Unit (IMU) and include tri- axial gyroscopes (gyros), tri- axial accelerometers, tri- axial magnetometers, and a pressure altimeter . This technology provides direct measurements of acceleration, angular rate, magnetic field, pressure, Delta-theta (change in angular rate), and Delta-velocity (change in velocity). Temperature and pressure sensors provide environmental information for measurement compensation and altitude estimations. information can be read directly but is not used internally for attitude or navigation estimations on the 3DM-GX5-25.

Computed estimations for attitude and heading reference systems (AHRS) are available outputs on the 3DM-GX5-25. To achieve these estimations, the MEMS sensors are processed by an AHRS Estimation Filter (EF) microprocessor with an Adaptive Kalman Filter (AKF) . Additional user settings such as measurement filtering, biasing, and tolerance values offer adjustments for specific applications.

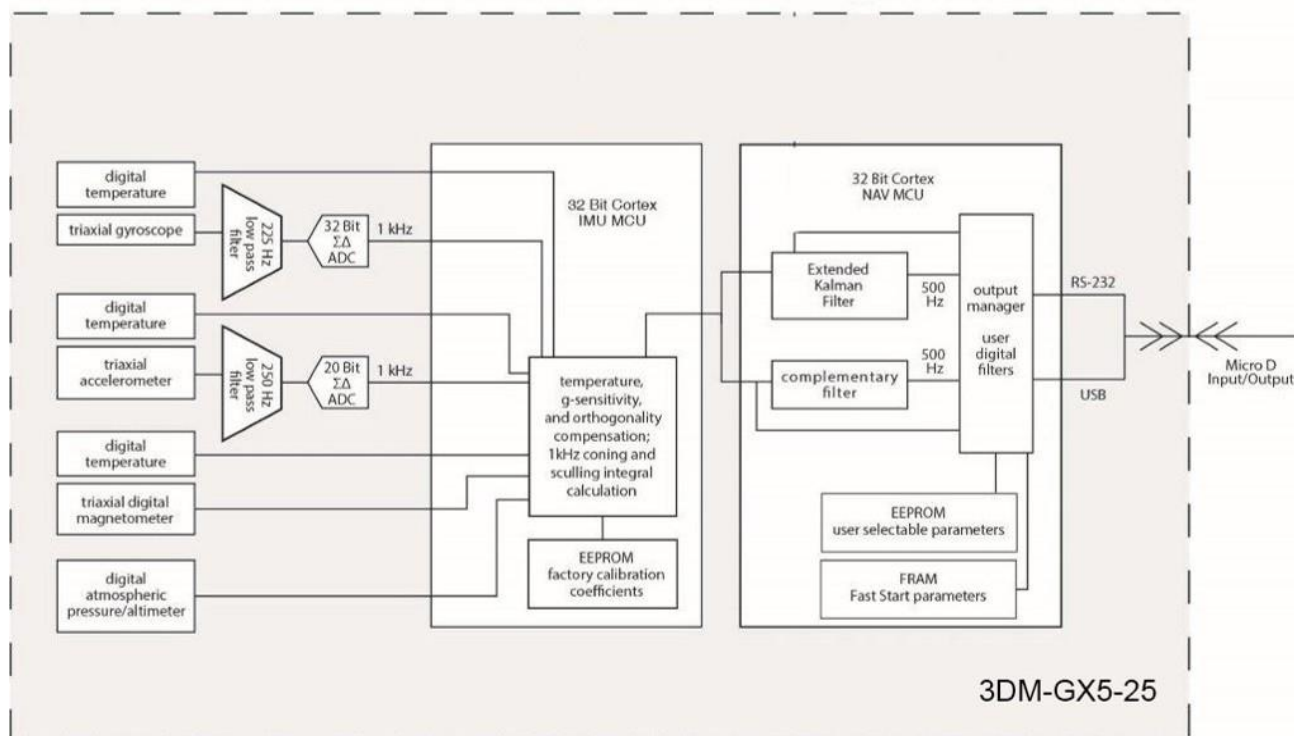

Figure 14 -3DM-GX5-25 Block Diagram

4.1 Direct Sensor Measurements (IMU Outputs)

The sensors in an Inertial Navigation System (INS), from which measurements for navigation and orientation are obtained, are collectively known as the Inertial Measurement Unit (IMU). These sensors are arranged on the three primary axes (x, y, and z) to sense angular rate, acceleration, and the local magnetic field. The gyroscopes are used to adjust the current attitude estimate when an angular rate is sensed. The accelerometers sense gravity as well as linear acceleration. The magnetometers sense the Earth's magnetic field along with local magnetic anomalies. All measurements are temperature-compensated and are mathematically aligned to an orthogonal coordinate system.

The IMU sensors can be read directly to report stand alone inertial measurements or computed measurements. Because the sensor system is digital, the analog voltage readings from the sensors are converted into a digital equivalent value based on the volt-to-bit scale of the internal analog-to-digital voltage converter. In the MIP Monitor software the conversion values are not configurable, but there are user-settable options for how the measurement is made. These settings are available at: Settings > Device > IMU (tab). With the Help window open (accessed with the Help button), mousing over context-sensitive settings provides a detailed explanation of the setting (*Figure 15 - IMU Settings*).

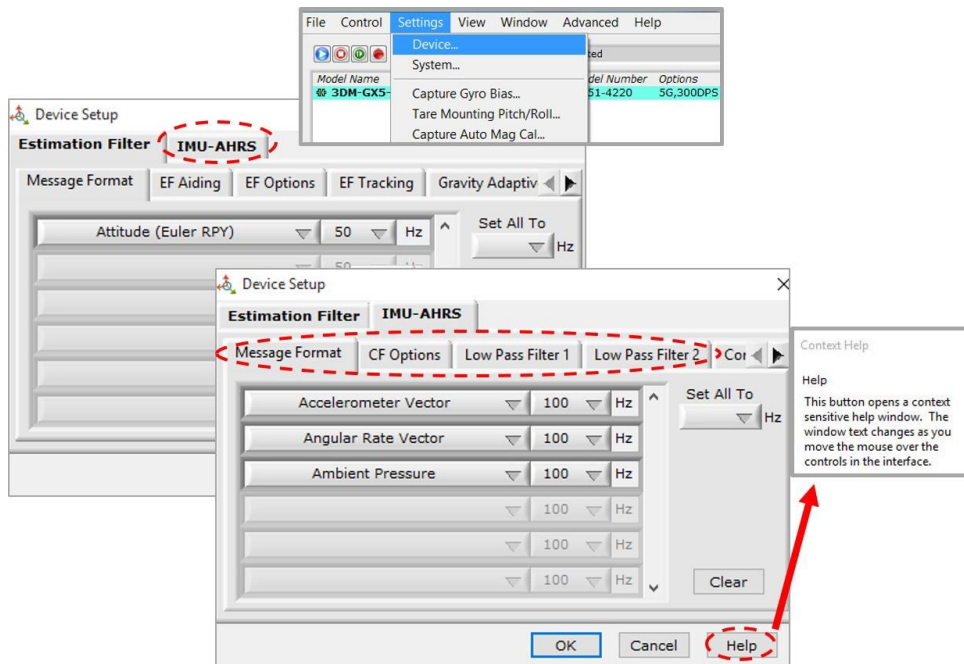

Figure 15 -IMU Settings

Table 2 - IMU Measurements lists the IMU measurements available for the 3DM-GX5-25. Additional measurement units may be available in MIP Monitor for some outputs, however they are converted values and do not represent the actual sensor outputs. Only actual output units are listed.

The Complementary Filter (CF) attitude, and up and north vector outputs are computed estimations from the LORD Sensing 3DM-GX3[®] inertial sensor family and are available to maintain backwards compatibility. For new applications it is recommended that these estimations be computed with the 3DM-GX5-25 EF Outputs algorithms (*see Computed Outputs on page 24*).

To view and record IMU outputs, *see Basic Setup and Operations on page 10*.

Measurement	Units	Description
Acceleration	gravitational force (g)	three axis acceleration readings in engineering units
Magnetic Field	Gauss (G)	three axis magnetic field readings in engineering units
Angular Rate	radian/second	three axis rotational velocity reading from gyroscope in engineering units
Delta Angle (Theta)	radians	time integral of angular rate with configurable time period
Delta Velocity	g*seconds	time integral of acceleration with configurable time period
GPS Clock Time	weeks, seconds, and status indicators	time metrics from the receiver for tracking IMU sensor data
Ambient Pressure	millibars	air pressure reading from pressure sensor
CF Attitude (Euler RPY)	radians	Complementary Filter (CF) Euler angles representation of orientation
CF Attitude (Matrix)	--	Complementary Filter (CF) matrix representation of orientation
CF Attitude (Quaternion)	--	Complementary Filter (CF) quaternions representation of orientation
CF North Vector	--	Complementary Filter (CF) north vector
CF Up Vector	--	Complementary Filter (CF) up vector

Table 2 - IMU Measurements

4.2 Computed Outputs

(Estimation Filter)

The computed outputs are measurements from the 3DM - GX5 - 25 IMU sensors that are blended through an Auto- Adaptive Extended Kalman Filter (EKF) algorithm. The Kalman Filter produces a better estimation of attitude and heading (AHRS) outputs than can be achieved by the inertial sensors individually. Refer to [Table 3 - Estimation Filter Outputs](#) for a complete list of outputs.

In the MIP Monitor software there are user-settable options for how the estimations are made. These settings are available at: Settings > Device > EF. With the Help window open (accessed with the Help button), mousing over context-sensitive settings provides a detailed explanation of the setting ([Figure 16 - Estimation Filter Settings](#)).

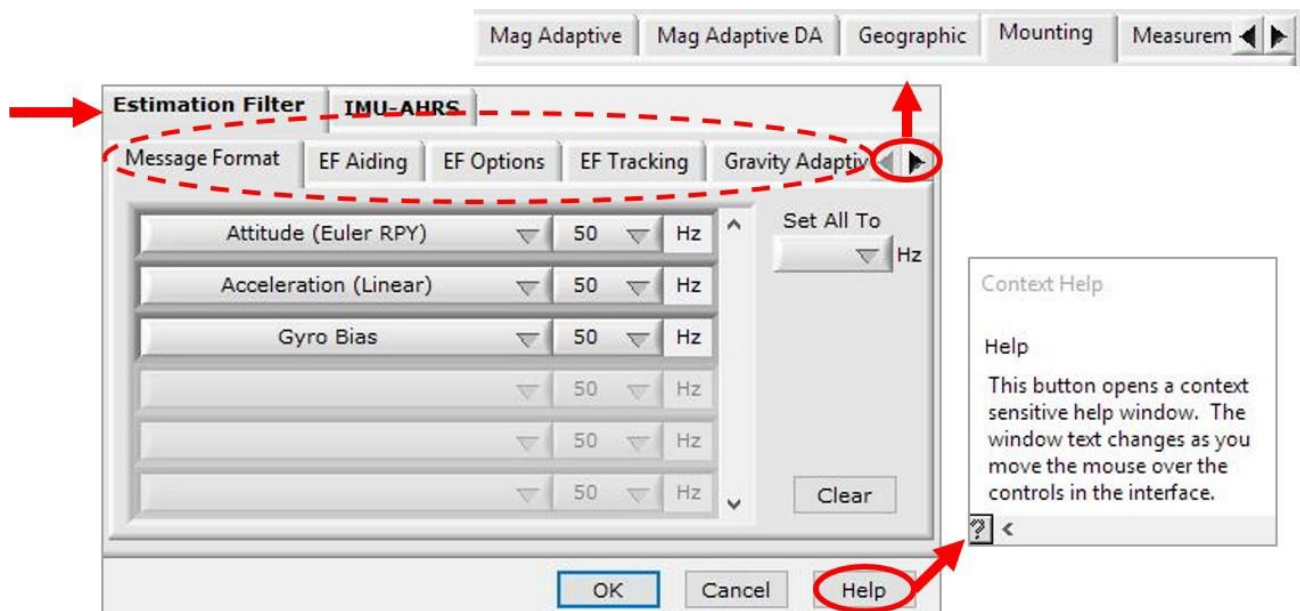

Figure 16 -Estimation Filter Settings

All of the estimation filter outputs are available to record and most, but not all, are available to view in real time in MIP Monitor. In addition to the standard attitude and heading (AHRS) solution, additional filter outputs, such as uncertainties, inertial sensor bias and scale factors, filter status, and physical models (WGS84, WMM, and SAM) are available ([Table 3 - Estimation Filter Outputs](#)).

To view and record Estimation outputs, [see Basic Setup and Operations on page 10](#).

Measurement	Units	Description
Filter Status	--	indicates the current state of the EF, such as running or initializing
GPS Time	weeks & seconds	GPS time corresponding to the calculated filter solution
Attitude (Euler RPY)	radians	Euler angles representation of orientation expressed as roll, pitch and yaw (RPY) with one-sigma uncertainty estimation available
Attitude (Matrix)	--	transformation matrix that describes orientation with reference to the Earth Centered Earth Fixed (ECEF) coordinate system
Attitude (Quaternion)	--	unit quaternions representation of orientation with one-sigma uncertainty estimation available
Acceleration (Linear)	meter/second ²	linear acceleration readings with reference to either the sensor or vehicle frame (depending on settings), with bias and scale readings, and one-sigma uncertainty estimations also available.
Compensated Angular Rate	radians/second	measured angular rate corrected using the estimated gyroscope scale factor and bias, with reference to either the sensor or vehicle frame (depending on settings)
Gravity Vector	meter/second ²	estimated WGS84 gravity vector with reference to either the sensor or vehicle frame (depending on settings)
WSG-84 Local Gravity Magnitude	meter/second ²	local WGS84 gravity vector magnitude
Heading Update	radians	heading used to update EF, calculated from the selected heading source (magnetometer, external, etc.) with one-sigma uncertainty reading available
WMM (World Magnetic Model)	Gauss	WMM local magnitude, inclination and declination based on GPS coordinates
Pressure Altitude	meters (altitude)	altitude estimate from barometric pressure
SAM	meters (altitude) pressure (milli-bars) temperature (°C) density (kg/m ³)	altitude as derived from the U.S. Standard Atmospheric Model (SAM) using the sensed barometric pressure and air temperature

Table 3 - Estimation Filter Outputs

4.3 Sensor Reference Frames

4.3.1 Geodetic Frame

The World Geodetic System is the standard for cartography and navigation. The latest revision, WGS84, is the reference coordinate system for GPS. It also calculates the magnitude of the local gravity vector using the WGS84 reference formulas.

The WGS coordinates are latitude (φ), longitude (λ), and height (h) above the reference ellipsoid. Latitude ranges from -90 degrees at the South Pole to 90 degrees at the North Pole. Longitude ranges from -180 to 180 degrees, with 0 degrees being the prime meridian. The -180/180 degree switchover occurs in the middle of the Pacific Ocean and includes a section of the International Date Line. The model takes into account the oblateness of the Earth's surface.

A point (P) on or above the Earth in the WGS84 coordinate system is notated as: latitude (φ), longitude (λ), and height above the reference ellipsoid (h).

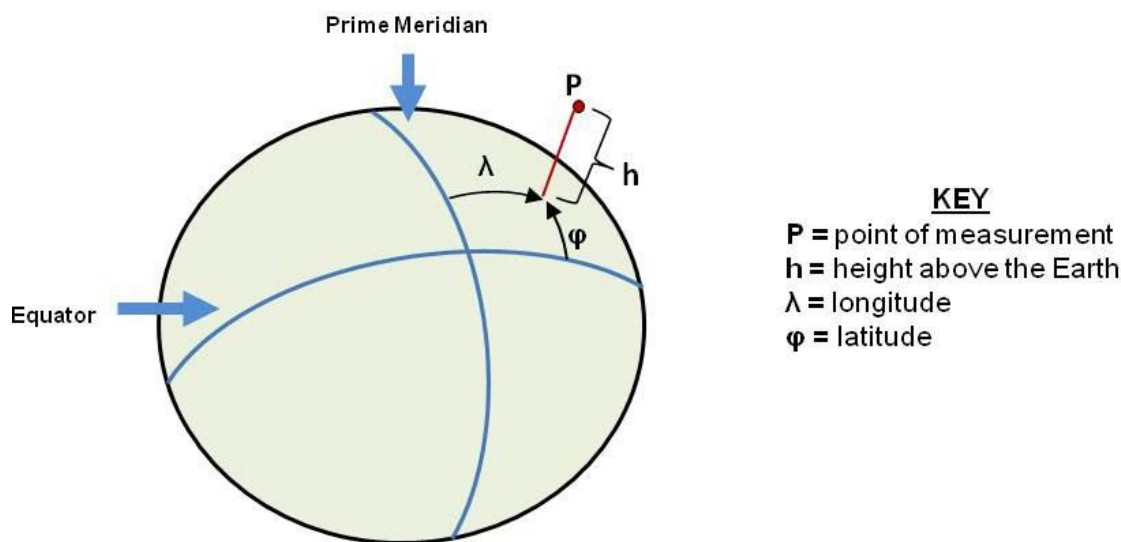

Figure 17 - World Geodetic System (WGS84) Reference Ellipsoid

4.3.2 North East Down (NED) Frame

The North-East-Down (NED) frame is a local coordinate frame, which is formed by a tangent plane located at a particular point (current coordinates) on the WGS84 reference ellipse. The NED frame is constructed with the (true) North vector along the line of longitude, the East vector along the line of latitude, and the Down vector normal to and towards the tangent plane (*Figure 18 - North East Down Frame*). The assumption when using the NED frame is that the local surface can be reasonably approximated by a flat plane. For most applications, this assumption is valid and provides a more intuitive reference frame for expressing attitude information than a global frame.

The 3DM-GX5-25 reports velocity in this frame and attitude with respect to this frame.

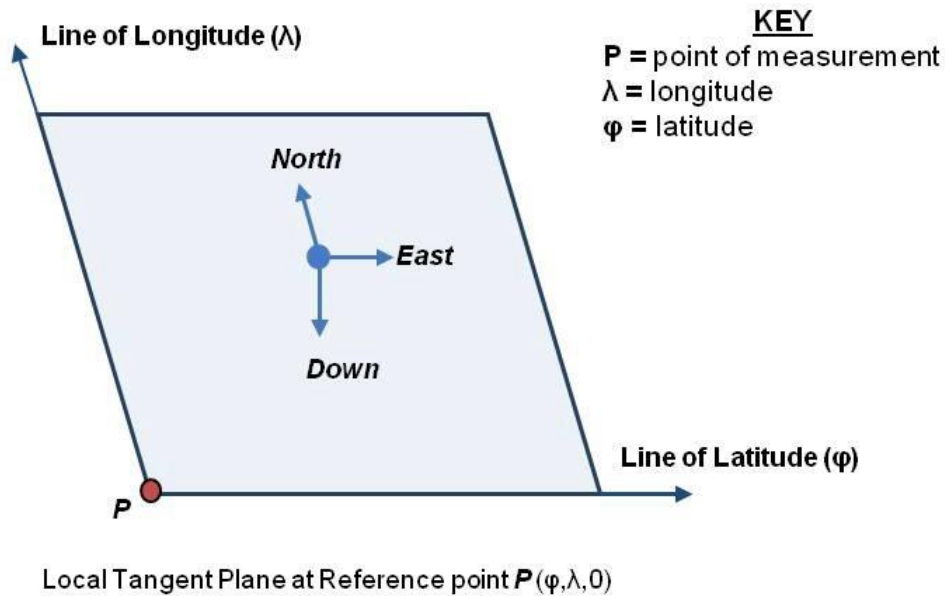

Figure 18 - North East Down Frame

4.3.3 Sensor Frame

The sensor frame is indicated on the top of the device and is oriented such that the x-axis vector is parallel with the long side of the sensor and points toward the sensor connector, the y-axis is 90° to the right of the x-axis, and the z-axis goes through the bottom of the sensor (outward). These axes were selected so that when the connector on the device is pointed north and the device is upright and level, the sensor frame will match the NED frame exactly, giving zero rotation.

The 3DM- GX5- 25 reports acceleration, angular rate, delta- theta, delta- velocity, inertial sensor biases and corrections in this frame. When no sensor-to-platform frame transformation has been provided ([see Platform Frame on page 29](#)).

The orientation of the sensor frame with respect to the local NED frame can be viewed in the MIP Monitor software at: View > 3D Attitude menu. This window displays the orientation of the sensor in relationship to north and shows measurement origination for acceleration and angular rate. The view can be rotated for clicking, holding, and dragging the image. Options for true north and magnetic north geo- references are available through the magnetic declination correction setting at: Device Settings > EF settings > Geographic.

Refer to the 3DM-GX5-25 dimensional diagram for the location of the measurement origin ([see Sensor Dimensions and Origin on page 64](#)).

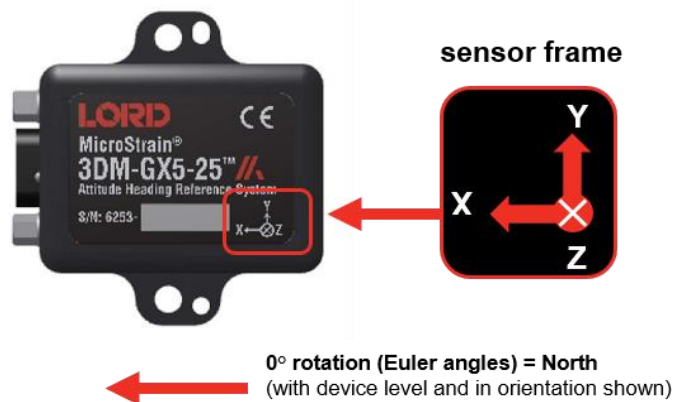

Figure 19 -Sensor Frame

4.3.4 Platform Frame

The 3DM-GX5-25 includes the option to define an orientation transformation and offset distance from the sensor frame to a user-definable platform frame. This is useful when the sensor cannot be mounted in the same location or orientation as the desired reference point on the platform frame. The transformation from sensor to platform frame is defined with Euler angles and is expressed as a rotation from the sensor frame to the platform frame.

In the following example the user has defined the desired reference point on the platform frame to be located at the front bumper of the vehicle. In accordance with aircraft co-ordinate systems the platform frame is oriented with the x-axis pointed in the forward direction of travel, the z-axis pointed down, and the y- axis pointed towards the passenger side. The sensor has been mounted face down toward the rear of the vehicle, two meters from vehicle reference location with no offset in the y-axis and z-axis directions. The proper transformation in this example would be: 180 degrees roll, 0 degrees pitch, and 0 degrees yaw.

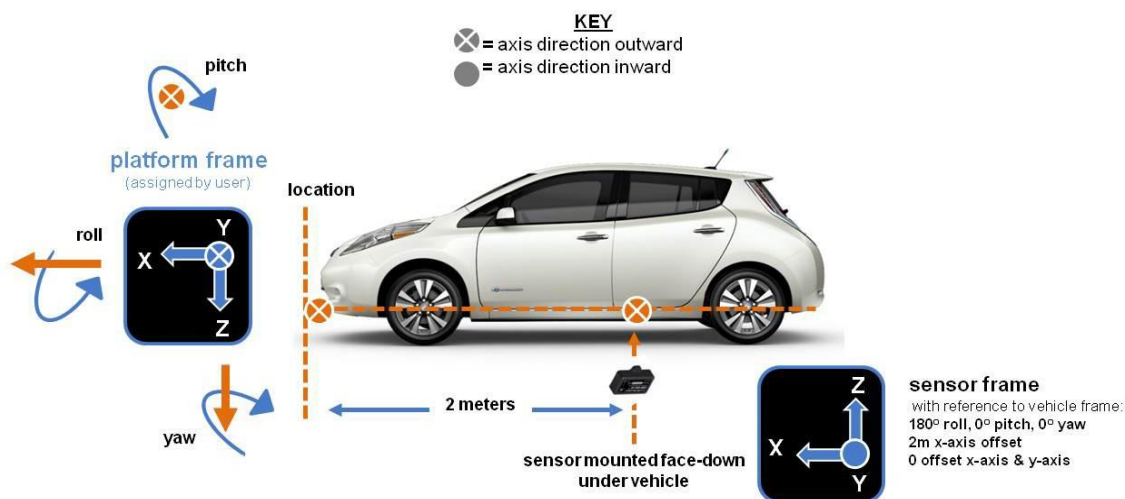

Figure 20 -Platform Frame Transformation

In the MIP Monitor software the transformation settings are entered at: Settings > Device > Estimation Filter > Mounting in the field (*Figure 21 - Platform Frame Settings*). To tare pitch-roll, *see Tare Mounting Pitch-Roll on page 32*.

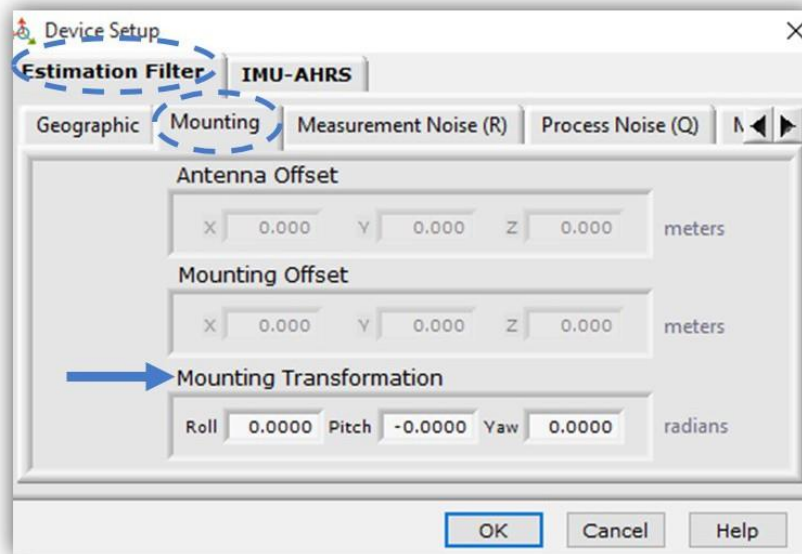

Figure 21 -Platform Frame Settings

The orientation transformation affects the following EF outputs: attitude, position, linear and compensated acceleration, compensated angular rate, and gravity vector. It also affects the following IMU outputs: acceleration, angular rate, magnetic field vector, delta Theta, and delta velocity (*see Computed Outputs on page 24*).

Transformed acceleration is expressed at the location of the sensor but within the platform frame. For example, if the sensor is offset from the center of gravity (CG), and the platform is undergoing a rotation, an acceleration (in addition to any linear acceleration of the CG) will be sensed in accordance with the following formula: (tangent acceleration) = (angular rate)*(distance from CG).

5. Performance Optimization

5.1 Gyroscope Bias

Gyroscope biases (offsets) can be zeroed out to set a baseline value for the static home position and conditions in the application. This should be done after sensor installation.

To set the gyroscope baseline, place the sensor or sensor platform in the desired home position. Allow 2-3 minutes for the sensor to warm up and for the temperature to stabilize for the best bias capture. Select Settings > Capture Gyro Bias ([Figure 22 - Gyro Bias Capture](#)). The sensor must remain stationary for about twenty seconds while the outputs are being measured. A status message will appear when the capture has been completed.

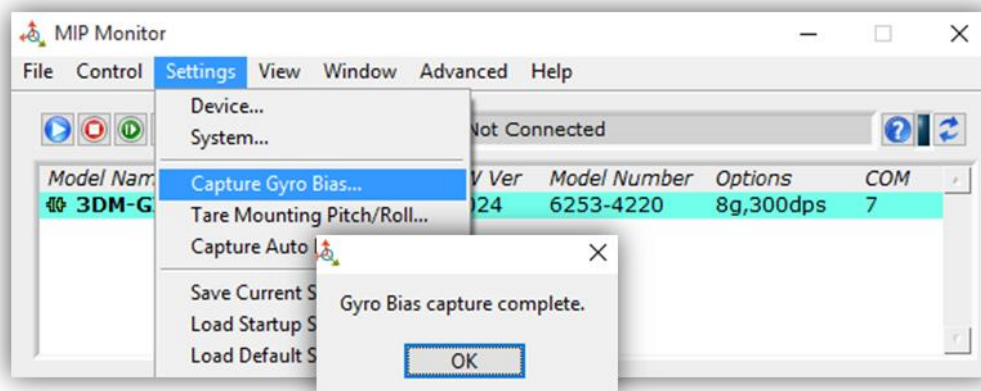

Figure 22 -Gyro Bias Capture

5.2 Tare Mounting Pitch-Roll

This function captures the current pitch-roll orientation of the device and sets it as the level reference, providing a convenient way to set the sensor to vehicle frame transformation. For more information on the corresponding LORD Sensing MIP Data Communications Protocol (DCP) command, see the DCP Manual .

NOTE

The filter must be initialized and have a valid attitude output. If the attitude is not valid, an error will be returned. The Tare Mounting Pitch-Roll assumes that the X-axis is co-aligned with the X-axis of the vehicle.

To tare the pitch-roll, select the sensor name in the MIP Monitor software main window, then select Settings > Tare Mounting Pitch/Roll > OK.

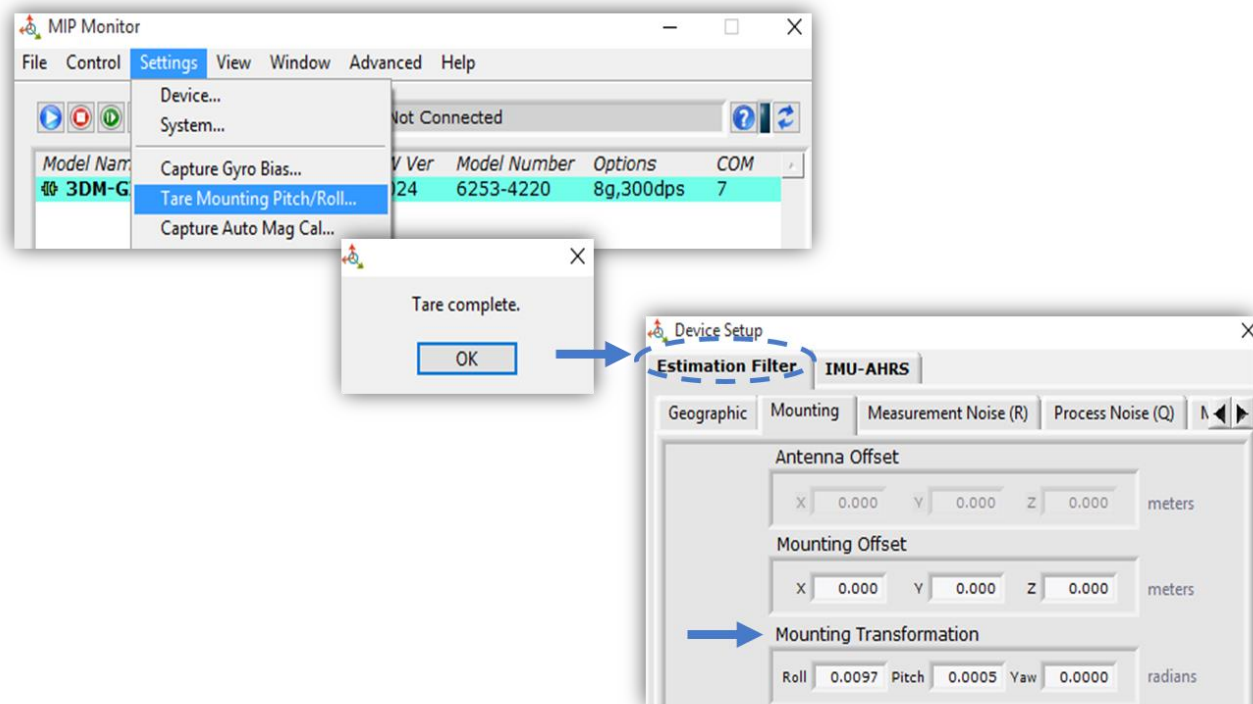

Figure 23 -Tare Mounting Menu

5.3 Magnetometer Auto Calibration

5.3.1 Enable

Enabling the EF Mag Hard Iron Auto Calibration allows estimation of the magnetometer bias (bias tracking) for purposes of auto- calibration. Enabling the EF Mag Soft Auto Calibration allows estimation of the magnetometer scale factor (scale factor tracking) for purposes of auto-calibration.

To enable, select the sensor name in the MIP Monitor software main window, then select Settings > Device > Estimation Filter > EF Tracking and check the white box to the left of Enable EF Mag Hard Iron Auto Calibration and Enable EF Mag Soft Iron Auto Calibration. Auto Calibration only takes place if the magnetometer is used as a heading aiding source.

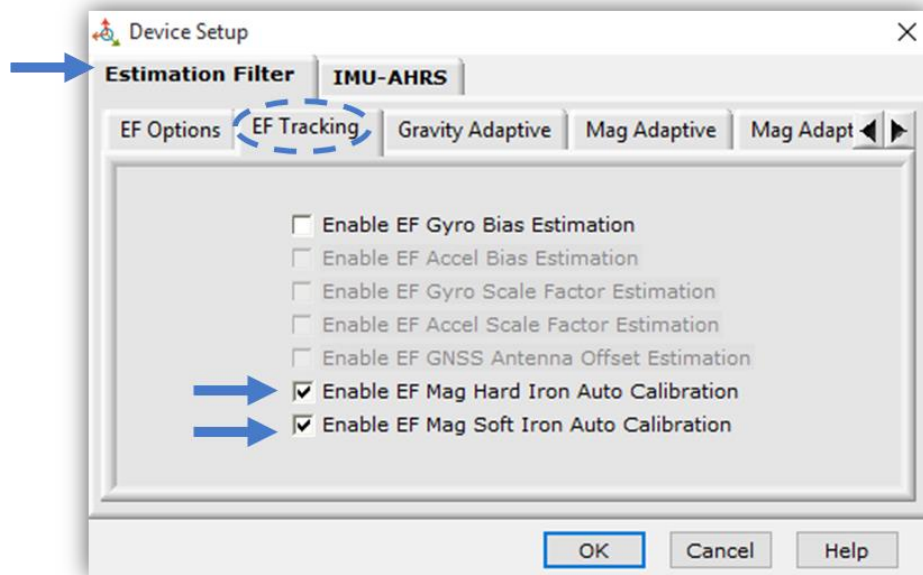

Figure 24 -Enable Auto Mag Calibration

5.3.2 Capture

This command captures the current value of the auto-calibration, applies it to the current fixed hard and soft iron calibration coefficients, and replaces the current fixed hard and soft iron calibration coefficients with the new values. This may be used in place of (or in addition to) a manual hard and soft iron calibration (*see Magnetometer Manual Calibration on page 35*) utility such as the LORD MIP Hard and Soft Iron Calibration software, which is included in the MIP Monitor software suite (*see Software Installation on page 11*).

This command also resets the auto-calibration coefficients. The Capture command should only be executed after the vehicle has undergone a series of maneuvers typical of actual operating conditions. These maneuvers are necessary to establish the magnetometer offset and scale factors. For more information on the corresponding LORD Sensing MIP Data Communications Protocol (DCP) command, see the DCP Manual .

To capture, select the sensor name in the MIP Monitor software main window, then select Settings > Capture Auto Mag Cal > OK > OK.

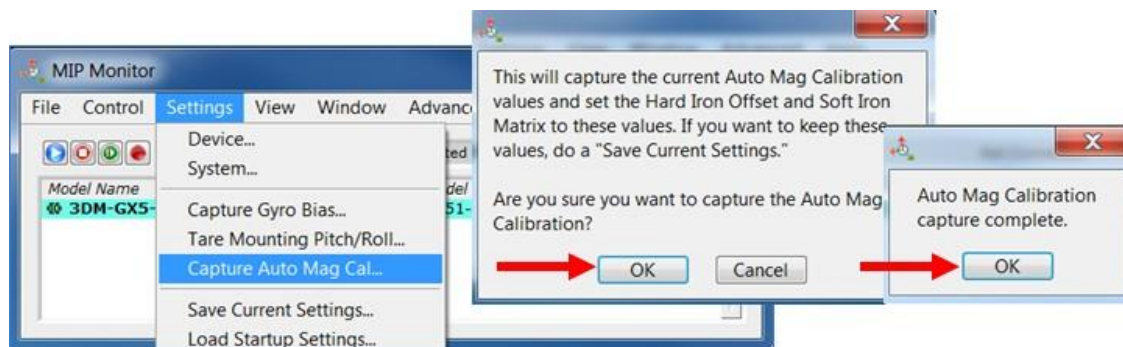

Figure 25 -Capture Auto Mag Calibration

5.4 Magnetometer Manual Calibration

Although the 3DM - GX5 - 25 magnetometers are calibrated at the factory to remove any internal magnetic influences in the device, measurements are still subject to influence from external magnetic anomalies when the sensor is installed. These anomalies are divided into two classes: hard iron offsets and soft iron distortions. Hard iron offsets are created by objects that produce a magnetic field. Soft iron distortions are considered deflections or alterations in the existing magnetic field. Ideally, these influences are mitigated by installing the sensor away from magnetic sources, such as coils, magnets, and ferrous metal structures and mounting hardware. However, often these sources are hard to avoid or are hidden.

To mitigate this effect when using the 3DM-GX5-25 magnetometer to aid in heading estimations, a field calibration of the magnetometer after final installation is highly recommended. This can be accomplished using LORD Sensing MIP Hard and Soft Iron Calibration software. The following are instructions for field calibrating the magnetometers:

1. Connect and power- on the sensor as normal, and open the MIP Hard and Soft Iron Calibration software.
2. Enter the Local Magnetic Field information for the sensor to account for magnetic influences inherent to the sensor's geographic location on the Earth. As needed, use the WMM on Web button to access a World Magnetic Model calculator on the British Geographic Survey website. This site, and similar sites, generate Local Magnitude F values based on latitude and longitude entries. In the calculator solution, these values will be found in row MF, column F.

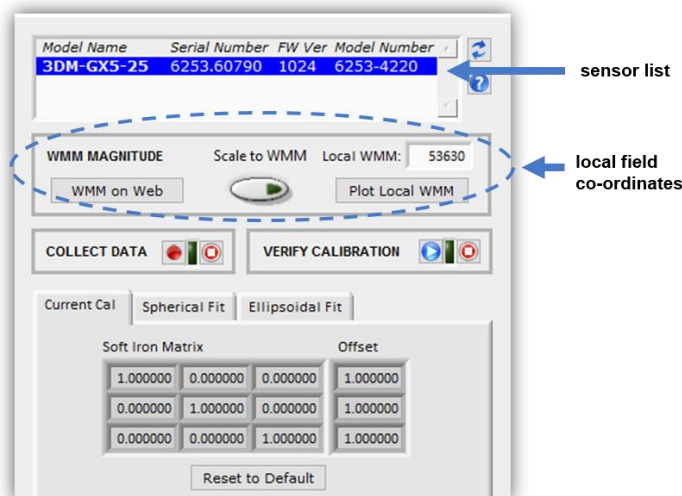

Figure 26 -Sensor Menu

- The sensor should automatically appear in the sensor list. If not, use the Refresh button to query it and then select the sensor (*Figure 26 - Sensor Menu*).
- Select the Arm Recording button next to Collect Data. The software will begin taking readings, as indicated by the points counter in the graphing window. The maximum number of points is 1000, however 100 is usually adequate. As the readings are taken, rotate the sensor or sensor platform in all possible directions to get a complete profile of the baseline magnetic influences throughout the sensor frame. Data points will appear on the graph in red. For mobile sensor platforms, such as ground vehicles, move the platform as much as possible to simulate actual use without exposing it to excessive magnetic sources (such as driving over railroad tracks or near steel pilings). The intention is to get a baseline of the platform in a neutral environment that still accounts for the platform itself in all orientations. For stationary platforms the baseline may include significant magnetic influences that will be present during operation.

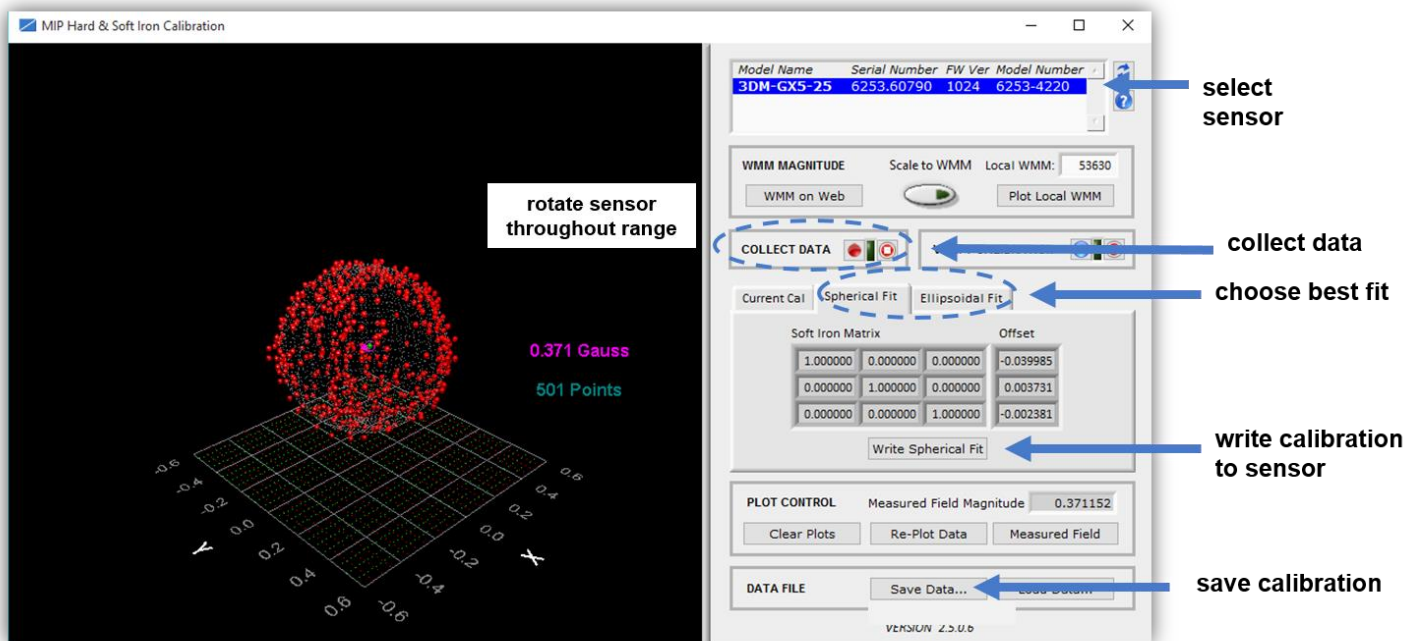

Figure 27 -Collect Calibration Data

- When all possible rotations are completed, select "Stop Streaming" next to Collect Data, and then select Save Data to save the calibration data points on the host computer.
- Click the Spherical Fit or Ellipsoid Fit button, depending on the application (*Figure 27 - Collect Calibration Data*). Spherical Fit is often best for applications with calibration rotations restricted to a 2D plane: for example, a ground vehicle or a boat, because it will

not likely not be rotated on all three axis. Ellipsoid Fit is generally a better correction when soft iron effects are present but only if enough data points can be collected in all quadrants. If the range of motion is restricted in one dimension, the Spherical Fit may be the best choice. If there are enough points in all dimensions, the Ellipsoid Fit may be better. Generally, if the Spherical and Ellipsoid Fits are close in the mean diameter, then the Ellipsoid Fit will be the best choice.

7. Click Write Spherical Fit or Write Ellipsoid Fit accordingly. This will write the values to the sensor memory.
8. Cycle power to the sensor if prompted, and then use the Refresh button, if needed, to re-establish communication with the sensor.
9. Start a calibration verification by clicking the Start Streaming Data button next to Verify Calibration (*Figure 28 - Verify Calibration*). Rotate the device in all orientations in the same way as during calibration. When completed click the Stop Streaming Data button next to Verify Calibration. The resulting data points should be on or near the spherical grid. Hold the left mouse button and drag to rotate the image. The mouse wheel can be used to zoom in and out. If the fit is not close, the sensor may require re-calibration. If it is close, as shown, calibration and verification is complete.

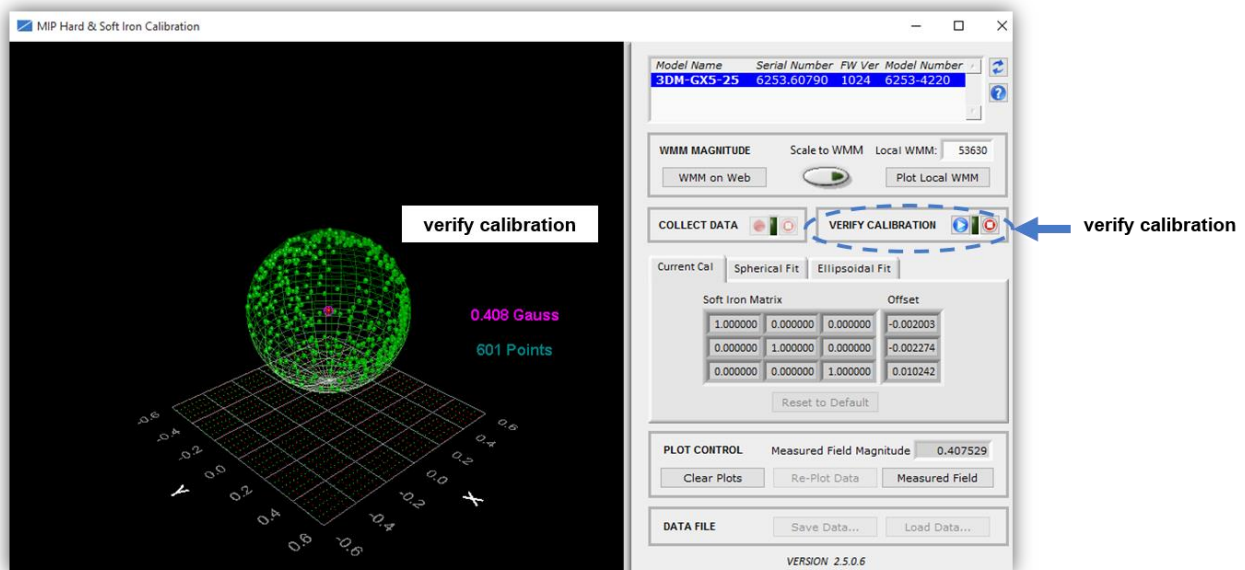

Figure 28 -Verify Calibration

5.5 Estimation Filter Aiding

There are two categories to customize heading and pitch-roll. To enter the Estimation Filter Aiding menu, select the sensor name in the MIP Monitor software main window, then select Settings > Device > Estimation Filter > EF Aiding.

1. Heading Aiding has three options including, None, Magnetometer and External Heading Message.
2. Pitch/Roll Aiding has two options including, None and Gravity Vector.

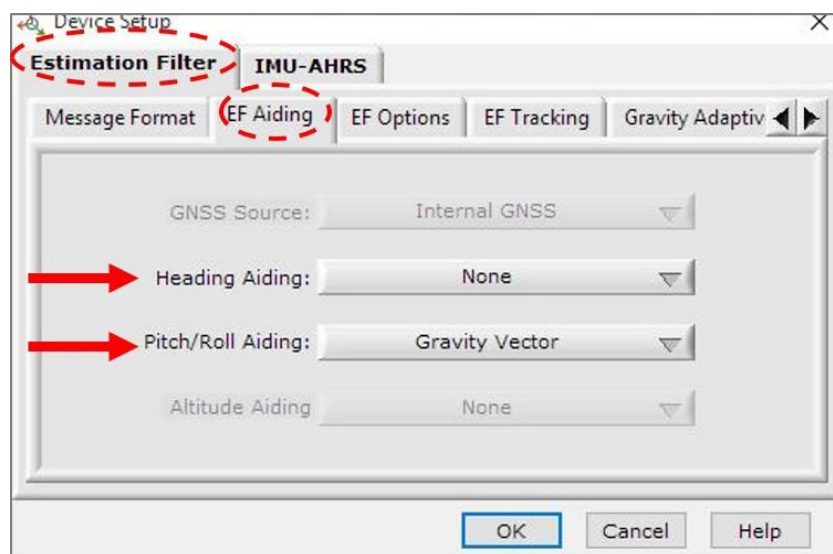

Figure 29 -EF Aiding Options Menu

5.6 Heading Aiding Settings

Device settings are stored in the sensor memory. Only the configuration options that are available for the type of sensor being used are displayed in the configurations menus. The 3DM-GX5-25 has two heading options.

If the setting is none, the estimated heading will drift when little-or-no changes in velocity are sensed (e.g. when stationary or traveling in the same direction at a constant velocity). If the setting is the magnetometer, there will be no drift, but the accuracy will only be as good as the magnetometer measurement. The external heading message setting means the heading is derived from one of two possible external messages provided by the user: 1. (0x0D, 0x17) or 2. (0x0D, 0x1F) in the LORD Sensing MIP Data Communications Protocol (DCP) DCP Manual.

For all settings, moving the platform in a dynamic way will assist in capturing an accurate heading.

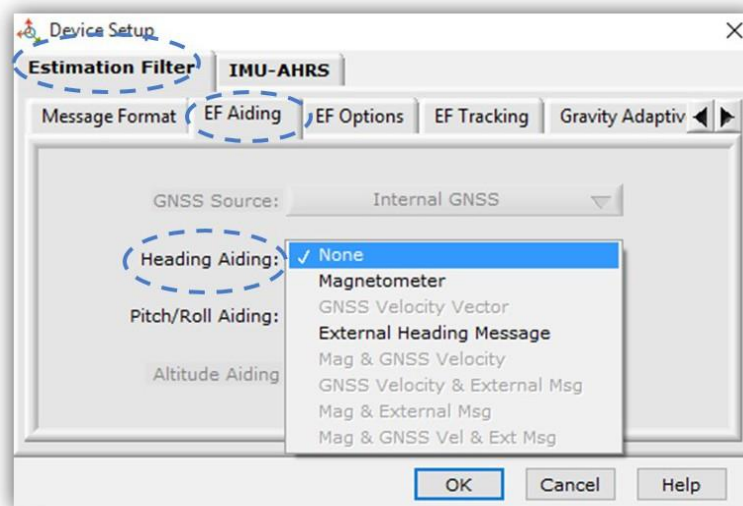

Figure 30 -Heading Aiding Settings

5.6.1 Bias Convergence

Accurate estimation of the biases can take several minutes to converge, therefore after the filter is initialized, the free-inertial performance will continue to improve until the bias estimations settle. The MEMS sensor manufacturers quote bias drift stability numbers which correspond to the expected drift in bias while the sensor is operating. The filter attempts to track the changing biases over time, and a user can expect these bias estimates will be non-constant during a navigation run.

5.7 Adaptive Anomaly Rejection

5.7.1 Gravity Adaptive

Enabling this feature allows the filter to stabilize attitude readings when undergoing linear accelerations. The bandwidth setting determines the cutoff frequency of the filter applied to linear acceleration changes ([see Communications Bandwidth on page 42](#)). The high and low limits determine the trigger points at which the stabilization is applied. The limit values are in meters/second² and the bandwidth is in Hz. To find this setting, select the sensor name and then Settings > Device > Estimation Filter > Gravity Adaptive.

Manual Adaptive (default setting): Enter user-set fixed values.

Auto-Adaptive: Automatically estimates the values internally.

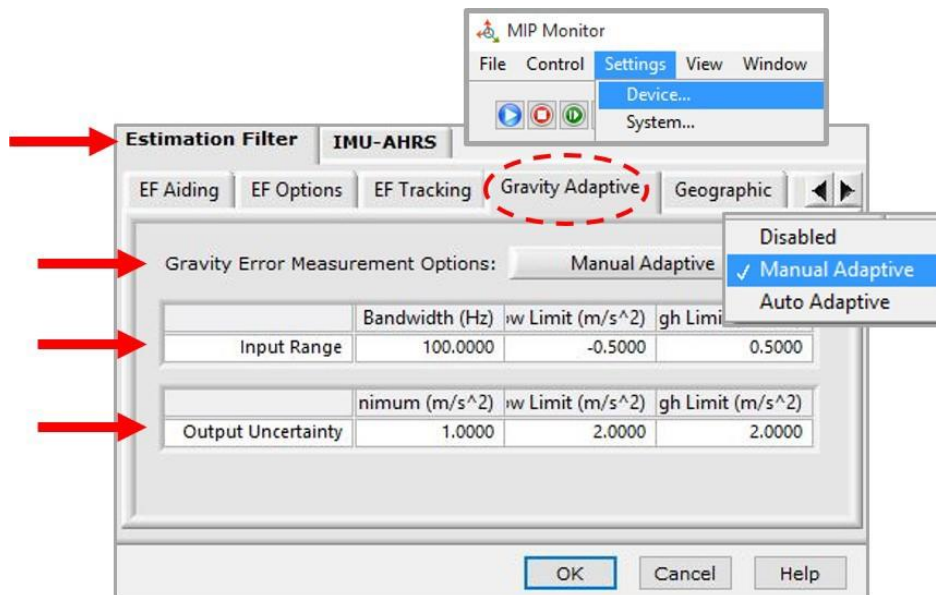

Figure 31 - Gravity Adaptive Settings

5.7.2 Mag Adaptive

Enabling this feature will allow the filter to reject magnetometer readings when the magnitude error exceeds the high limit (in m/s^2). The bandwidth (in Hz) sets the cutoff frequency of the low pass filter applied to the magnetometer error (*see Communications Bandwidth on page 42*). To find this setting, select the sensor name and then Settings > Device > Estimation Filter > Mag Adaptive.

Manual Adaptive (default setting): Enter user-set fixed values.

Auto- Adaptive: Automatically estimates the values internally. It is important to have accurate location information (lat long) in order to have an accurate value for the local magnetic field magnitude.

NOTE

For best results, perform a hard and soft iron calibration or enable Auto-Mag calibration prior to initiating the Mag Adaptive function.

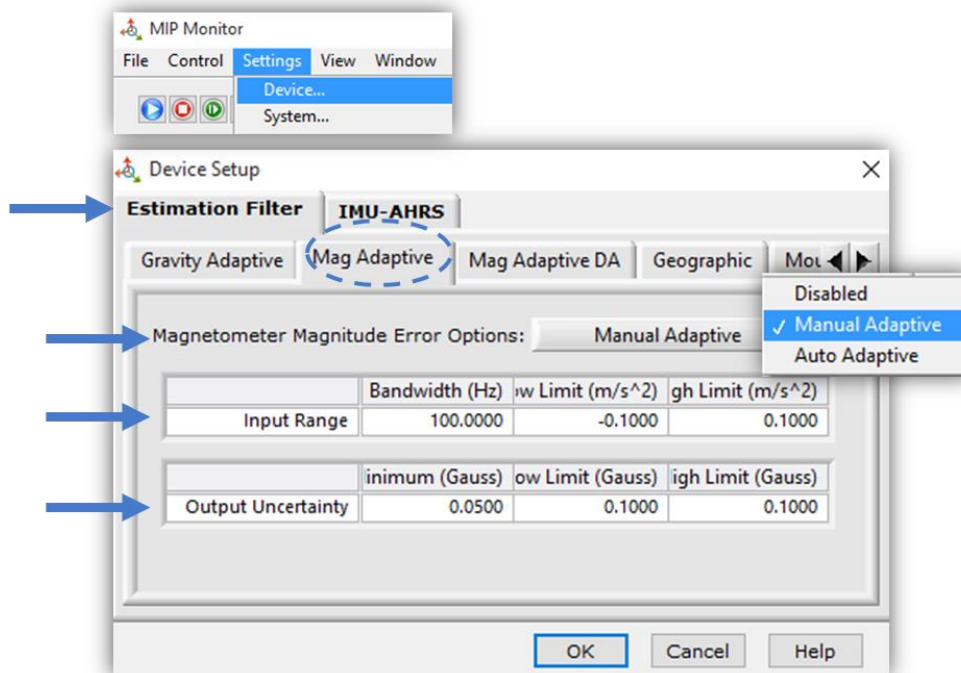

Figure 32 -Mag Adaptive Settings

5.8 Communications Bandwidth

When selecting sensor and estimation outputs to be recorded, communication bandwidth considerations should be taken into account, especially when using RS232 serial communications. Lower baud rates equate to lower communication bandwidth, which can be consumed quickly by selecting a large number of measurements at high sample rates. Overrunning the communication bandwidth will result in dropped data packets. Most computer RS232 ports are limited to 115,200 baud even though the 3DM-GX5-25 is capable of running at 921,600 baud.

5.9 Platform Frame Transformation

The transformation from the sensor frame to the platform frame (*see Platform Frame on page 29*) should be defined to the highest angular accuracy possible. The easiest way to accomplish this is to co-align the frames. If this is not possible, using a simple transformation (such as 90 or 180 degree rotations on a single axis) is preferred. For complex transformations between the frames, a calibration should be performed or analysis from a model should be conducted.

5.10 Estimation Filter Operation

The 3DM - GX5 - 25 combines the information from the IMU sensors to calculate an Attitude and Heading Reference System (AHRS) solution that incorporates the strengths of the individual sensors while minimizing their weaknesses.

In a conventional system, Attitude and Heading Reference System (AHRS), several sources of error exist when making attitude estimates. First, the algorithm assumes the acceleration vector is dominated by Earth's gravity, with only transient linear accelerations. When long- duration linear accelerations are experienced, such as when an aircraft performs a sustained 2G turn, the sensor will report incorrect pitch and roll angles. This error results from the assumption that the accelerometers are only sensing Earth's gravity. A second source of error occurs when the device attempts to measure the Earth's magnetic field. This field is very weak compared to the numerous magnetic anomalies typically found on platforms, or naturally occurring close to the Earth's surface. A third source of error occurs when attempting to navigate between geographic way- points expressed in latitude and longitude. This error is due to the difference between detecting magnetic north, which is output by the sensor, and true north, which is used to define lines of longitude. If the AHRS is always used in one geographical location, the user can correct for this difference using a constant offset. If the AHRS is used over a wide range of longitude, the magnetic declination must be calculated from a magnetic model.

The 3DM-GX5-25 runs an Auto-Adaptive Extended Kalman Filter as a full-state dynamics model. The state propagation utilizes Newton's and Euler's equations of motion with the acceleration and angular rate treated as control inputs.

The Kalman filter estimates the full state of attitude for a total of 16 states: 4 attitude (quaternion), 3 gyro bias, 3 magnetometer bias, and 6 magnetometer scale-factor states. The gyro bias states are estimated to compensate for the time-varying biases inherent in MEMS gyros, which are the largest error sources for these devices. The magnetometer bias and scale-factor states are estimated to compensate for magnetic field distortions (hard- and soft-iron errors). Note that only distortions that are fixed with respect to the sensor body coordinate frame of reference can be tracked. Tracking these errors automatically enhances the overall accuracy of the sensor and makes it easier to deploy.

The Kalman filter also provides statistical information about the quality of the estimated states described in a covariance matrix. The diagonal terms of the matrix are the variance of each state, thus the square root of these values are 1- sigma standard deviations. These values give the filter's estimation of how well it knows the individual states, given what it knows about the statistical properties of the noise sources of the various sensors and also provide feedback to the user as uncertainty values.

5.11 Estimation Filter Convergence

5.11.1 Initial Convergence

After a successful initialization, a period of convergence for the Kalman filter states occurs. Roll and pitch angles typically converge very quickly. Heading, accelerometer/magnetometer bias, and gyro bias take more time to converge. If the initial attitude estimate provided to the filter is well outside of the true attitude, the filter may diverge and never recover. This is most likely to occur for the heading estimate when a poor value is used for initialization and when the vibration environment is strong. Should this occur, it is recommended that the filter be reset and new attitude estimate provided.

5.11.2 Output Uncertainty

The 3DM-GX5-25 estimation data set includes a filter status field that contains a set of status flags. These flags pertain to high covariance values for attitude and inertial sensor parameters. These flags should be monitored and cross-checked against the corresponding uncertainty fields when they appear. This can assist in determining how trustworthy the solution generated by the Kalman filter is. When the filter is first initialized, it is likely that some of these values will be beyond limits, and the flags may be asserted. This fact should be taken into account when developing automated monitoring systems.

5.12 Vibration Isolation

The 3DM-GX5-25 should be isolated from strong vibrations as much as possible. Strong, continuous vibrations appear as unaccounted noise to the estimation filter, degrading its performance. When vibration cannot be isolated, making adjustments to the Accelerometer Noise and Gyro Noise parameters to account for the additional noise will improve the accuracy of the estimation filter outputs.

5.13 IMU Sensor Calibration

All of the internal sensors in the 3DM-GX5-25 are calibrated when the device is manufactured, and the calibration values are saved in the device memory. With the exception of the magnetometer field calibration ([see Magnetometer Manual Calibration on page 35](#)) recalibration is not required unless the device has been under conditions that exceed the operating specifications. For example, if the sensor has been exposed to excessive shock beyond the rated g-force, performance may be compromised. Indications of internal sensor damage may be seen as excessive measurement offsets or drift when the sensor is in a neutral motionless position.

5.14 Temperature Compensation

All sensor conversion and calibration formulas include temperature compensation. All computed outputs and IMU sensor outputs are automatically adjusted for local temperature.

5.15 Import and Export Settings

The import and export settings features provide a consolidated file of the user settings, enabling Device Settings information to be saved and shared. For example, exporting settings to the LORD technical support team helps facilitate fast and accurate resolution of technical issues.

To import the sensor settings, select the sensor name in the MIP Monitor software main window, then select Settings > Import Settings, then follow the prompt to choose where the file will be saved and name the file.

To export the sensor settings, select the sensor name in the MIP Monitor software main window, then select Settings > Export Settings, then follow the prompt to choose where the file will be saved, and select OK. The file will be named by default using the sensor name, serial number, date and time.

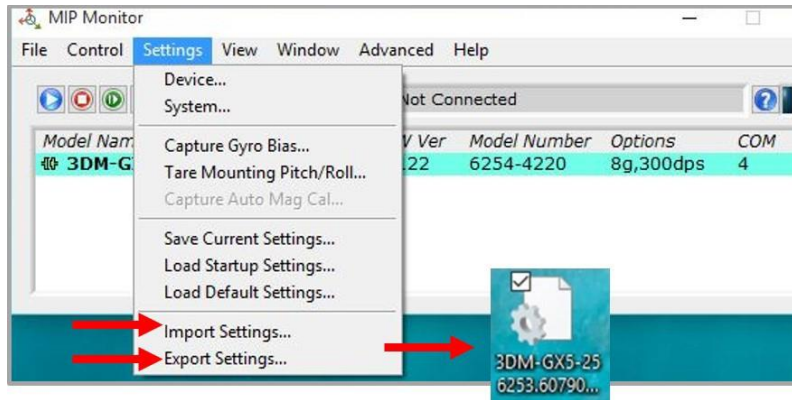

Figure 33 -Import/Export Settings Menu

6. Sensor Installation

6.1 Sensor Mounting

The 3DM - GX5 - 25 sensor housing is rated for indoor use only, unless used inside a protective enclosure.

The sensor has two mounting tabs with holes for fastening. Mounting screws should be brass or 300 Series stainless steel. Nylon washers and thread-lock are recommended. There are two additional holes used for precise alignment with 2mm dowel pins. One of the holes is slotted to allow for relaxed pin positioning accuracy. The sensor can be mounted in any orientation, as required for the application ([see Sensor Reference Frames on page 26](#)). The axes are labeled on the face of the sensor for reference, and the sensor measurement origin is shown in the sensor dimensional drawing ([see Sensor Dimensions and Origin on page 64](#)).

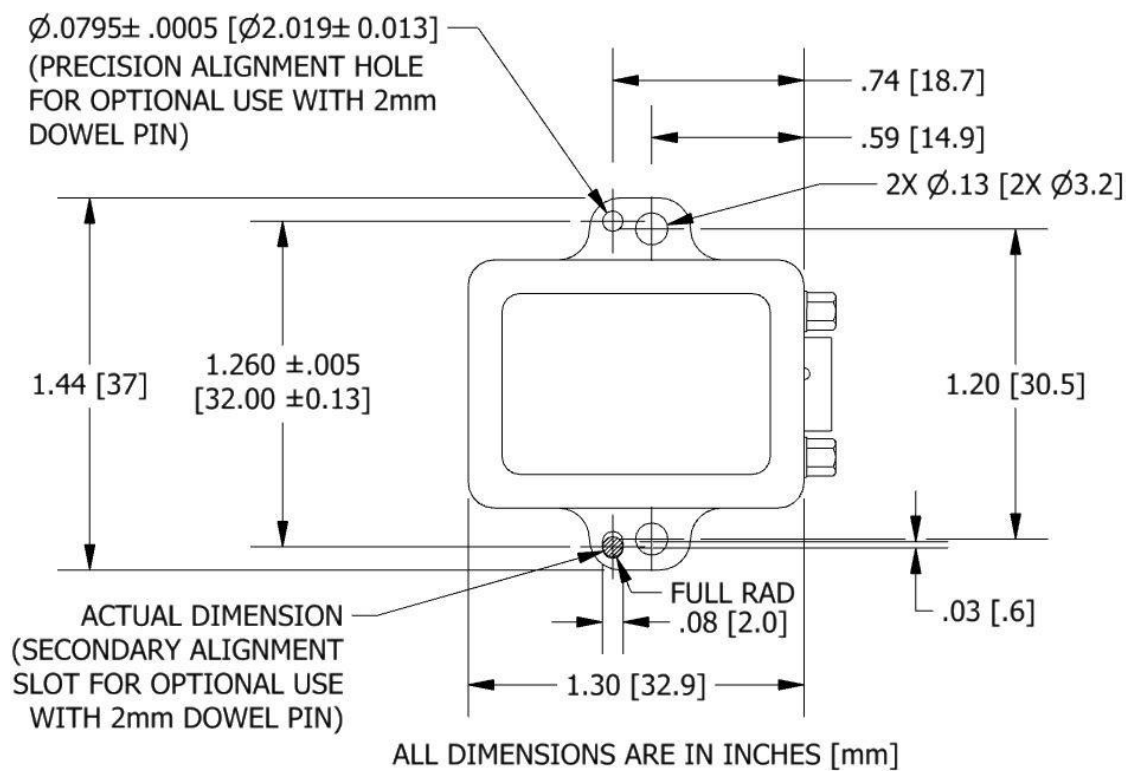

Figure 34 - Mounting the Sensor

7. OEM System Integration

The 3DM - GX5 - 25 connectivity kit comes with everything that is needed for sensor configuration, operation, and data collection. However, many applications will require custom solutions because of physical or environmental constraints, required sensor output processing, or for integration into control systems that react to the sensor outputs. (*See Sales Support on page 61*).

7.1 Data Communications Protocol (DCP)

The LORD Sensing MIP Data Communications Protocol (DCP) includes all commands available for controlling and acquiring data from the 3DM- GX5- 25, including many that are not available in the MIP Monitor software. Programming is performed through a standard serial interface program. The programming interface is comprised of setup and control commands and a very flexible user-configurable data output format. The commands and data are divided into four command sets and three data sets corresponding to the internal architecture of the device. The protocol is packet-based. All commands, replies, and data are sent and received as fields in a message packet. The packets have a descriptor- type field based on their contents, so it is easy to identify if a packet contains commands, replies, or data.

To view or download the 3DM-GX5-25DCP Manual go to:

<http://www.microstrain.com/support/documentation>

Select 3DM- GX5- 25 from the "Select a Product to View Documentation" drop- down menu. The manual will appear in a list under "General Documentation."

The MIP software developers kit (SDK) includes sample code and can be found on the LORD Sensing website Support page or by contacting Technical Support (*see Technical Support on page 58*).

The LORD Sensing MIP Data Communications Protocol (DCP) describes each command description, message syntax, and message option. It also provides examples, and can also be found on the LORD Sensing website or through Technical Support.

7.1.1 Packet Builder

To expedite program development, a packet builder tool is included in the MIP Monitor software. The packet builder allows users to send multiple packets to the 3DM-GX5-25 and view the resulting reply data.

Applicable protocol structure and design is described in the 3DM-GX5-25 LORD Sensing MIP Data Communications Protocol (DCP) Manual DCP Manual . For additional help, contact Technical Support ([see Technical Support on page 58](#)).

To use the packet builder select Advanced > Packet Builder from the MIP Monitor main window ([7.1.1 Packet Builder](#)). The sensor must be in the Standard communications mode to use this feature.

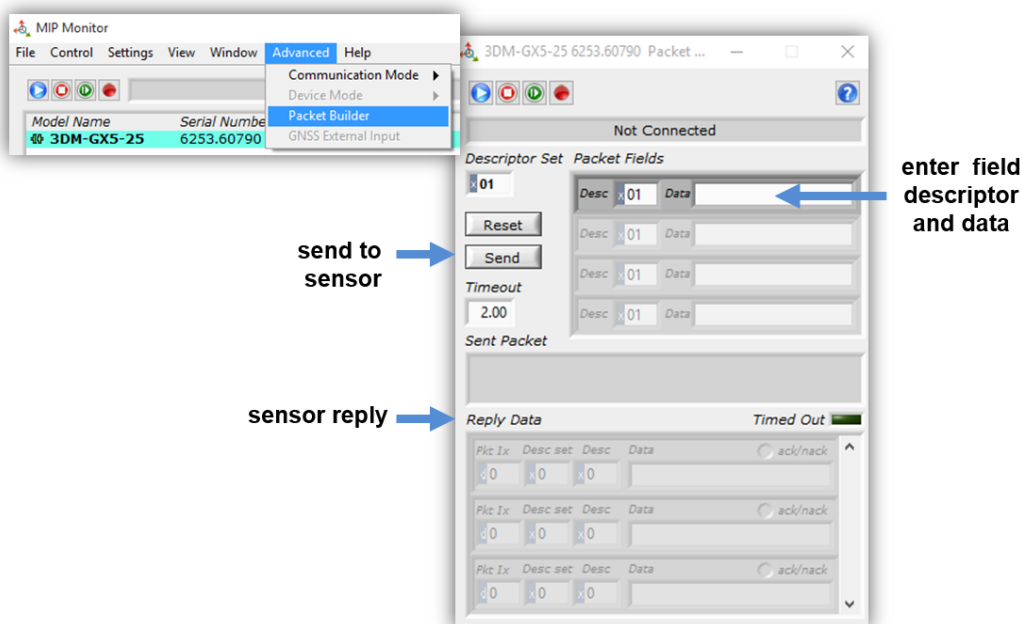

Figure 35 -Packet Builder

7.1.2 Sensor Direct Mode

The MIP Monitor software can be used to put the sensor in a mode that allows direct programmatic access to the internal Inertial Measurement Unit (IMU). The IMU has its own processor and protocol commands and native data outputs from the individual IMU sensors that may not be available in MIP Monitor.

When in Sensor Direct mode the device normal functionality is not available. The protocol commands used to interface with the IMU are a subset of the standard LORD Sensing MIP Data Communications Protocol (DCP) and are further described in the LORD Sensing MIP Data

Communications Protocol (DCP) manual. For additional information contact LORD Sensing Technical Support (*see Technical Support on page 58*).

To enter this mode select Advanced > Communications> Sensor Direct from the MIP Monitor main window. Once in this mode the device status message will indicate Sensor Direct Mode (*Figure 36-Sensor Direct Mode*).

To exit Sensor Direct Mode select the Refresh button in the MIP Monitor at any time, or use Advanced > Communication menu to select the Standard operating mode.

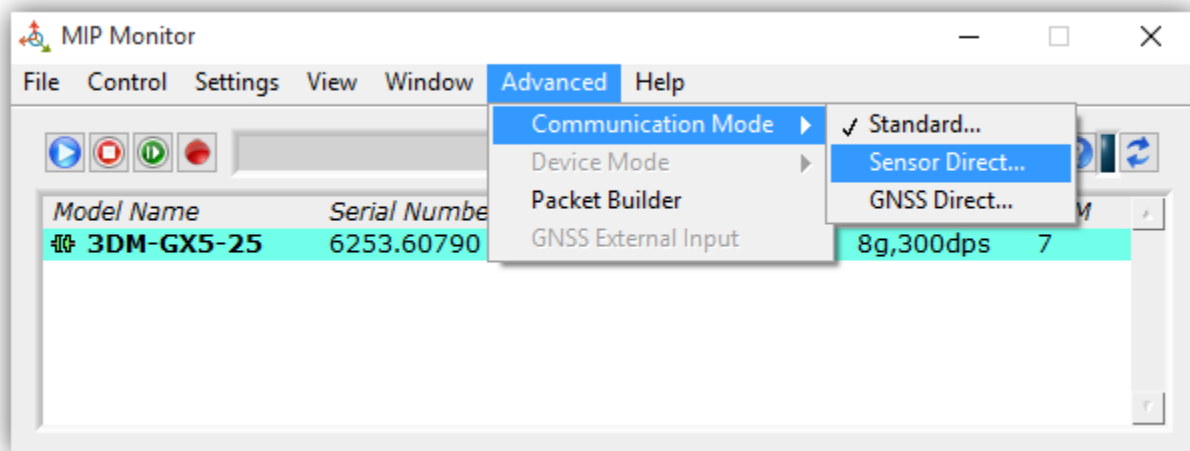

Figure 36 -Sensor Direct Mode

7.2 Sensor Wiring

WARNING

Only use power supplies within the operating range of the sensor, or permanent sensor damage or personal injury could result. There are two input power pins available, each with different voltage ranges. Connect only one at a time. Observe connection polarity.

Sensor power and serial communications cables are available from LORD Sensing and come with the sensor connectivity kits. These cables will have the micro-DB9 connector on one end (to connect to the sensor) and either a standard DB9 on the other end (for RS232 communication) or a USB connector (for USB communications). Alternately, the micro-DB9 can be purchased from LORD Sensing with flying leads or the connector by itself can be purchased from the manufacturer (Ulti-Mate Connector Inc). [See Parts and Configurations on page 59](#) for a list of available options. For the cable diagram, [see Sensor Dimensions and Origin on page 64](#).

The connector interface includes connections for USB and RS232 communications (only connect one), two options for sensor input power range (only connect one), and a precision hardware timing input (PPS input) for synchronizing with external timestamps. The sensor selects the appropriate serial communication (USB or RS232) on power-up based on which connection is used.

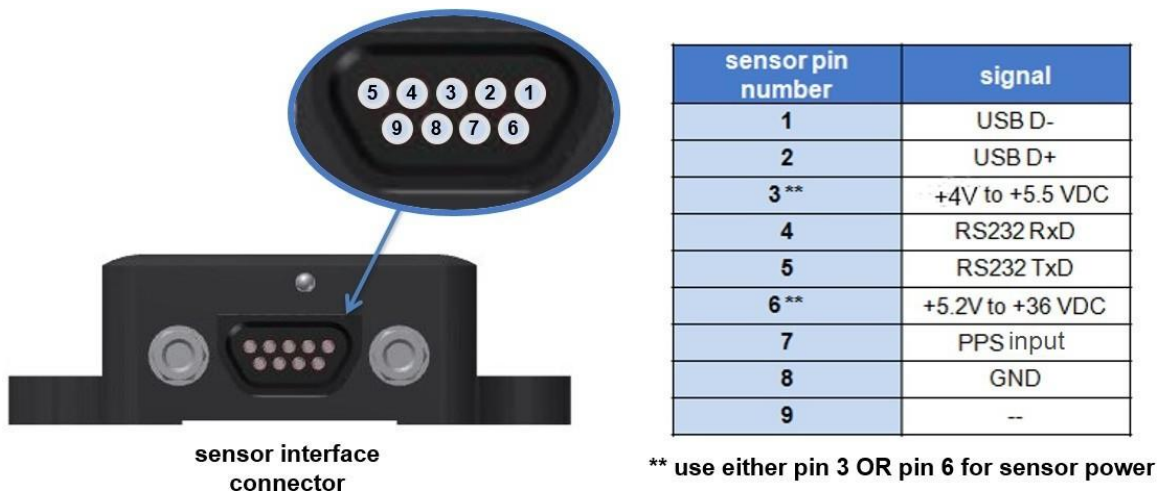

Figure 37 -Connector Wiring

7.3 Sampling on Start-up

The Save Current Settings command can be used to instruct the sensor to start streaming data as soon as it powered on. This can be useful in sensor integration applications in which immediate data acquisition is desired, and connection to MIP Monitor for data logging is not required. This functionality can also be embedded in user- designed applications by using the corresponding LORD Sensing MIP Data Communications Protocol (DCP) command. To view or download the DCP Manual, go to: <http://www.microstrain.com/support/documentation>, from the drop-down menu select 3DM-GX5-25, and then select document from the list.

NOTE

When setting the sensor to begin sampling on start-up, verify that the sensor is sampling by reading the status indicator on the device (*see Interface and Indicators on page 9*), or by viewing the serial data stream from the host computer. If communication with MIP Monitor is established, the sampling will stop to facilitate device configuration.

To save the current sensor configuration, first adjust the sensor settings to the desired values, and then start streaming. Next select Settings > Save Current Settings from the main window (*Figure 38 - Save Sensor Settings*). The setting will remain intact when the sensor is powered off and then on again.

To recall the last saved settings select Settings > Load Startup Settings.

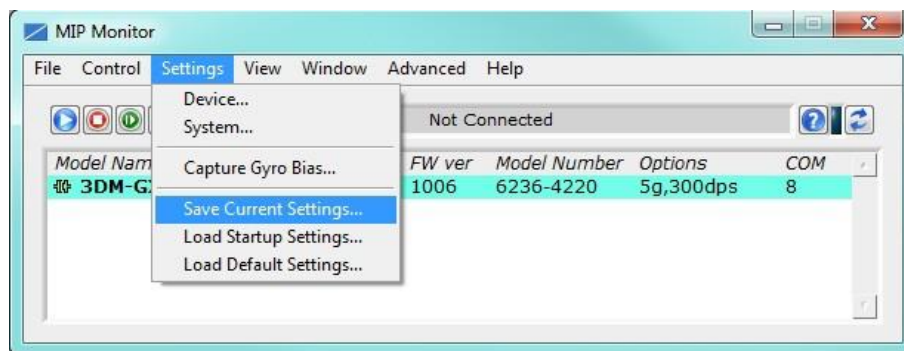

Figure 38 -Save Sensor Settings

7.4 Connecting to a Datalogger

Many inertial applications incorporate dataloggers of all different types to collect and distribute sensor outputs. For more information and examples refer to the "Using Dataloggers with Inertial Sensors" Technical Note on the LORD Sensing website, or contact LORD Sensing Technical Support ([see Technical Support on page 58](#)).

7.5 Using Wireless Adapters

In some applications it can be very useful to set up wireless communications between the sensor to the host computer. One way this can be accomplished is by connecting the serial output of the sensor to a serial to wireless converter and then connecting the wireless receiver to the host computer. For more information and an example refer to the "Using RS232 Bluetooth Adapters" Technical Note on the LORD Sensing website or contact LORD Sensing Inertial Sensor Products Technical Support ([see Technical Support on page 58](#)).

8. Troubleshooting

8.1 Troubleshooting Guide

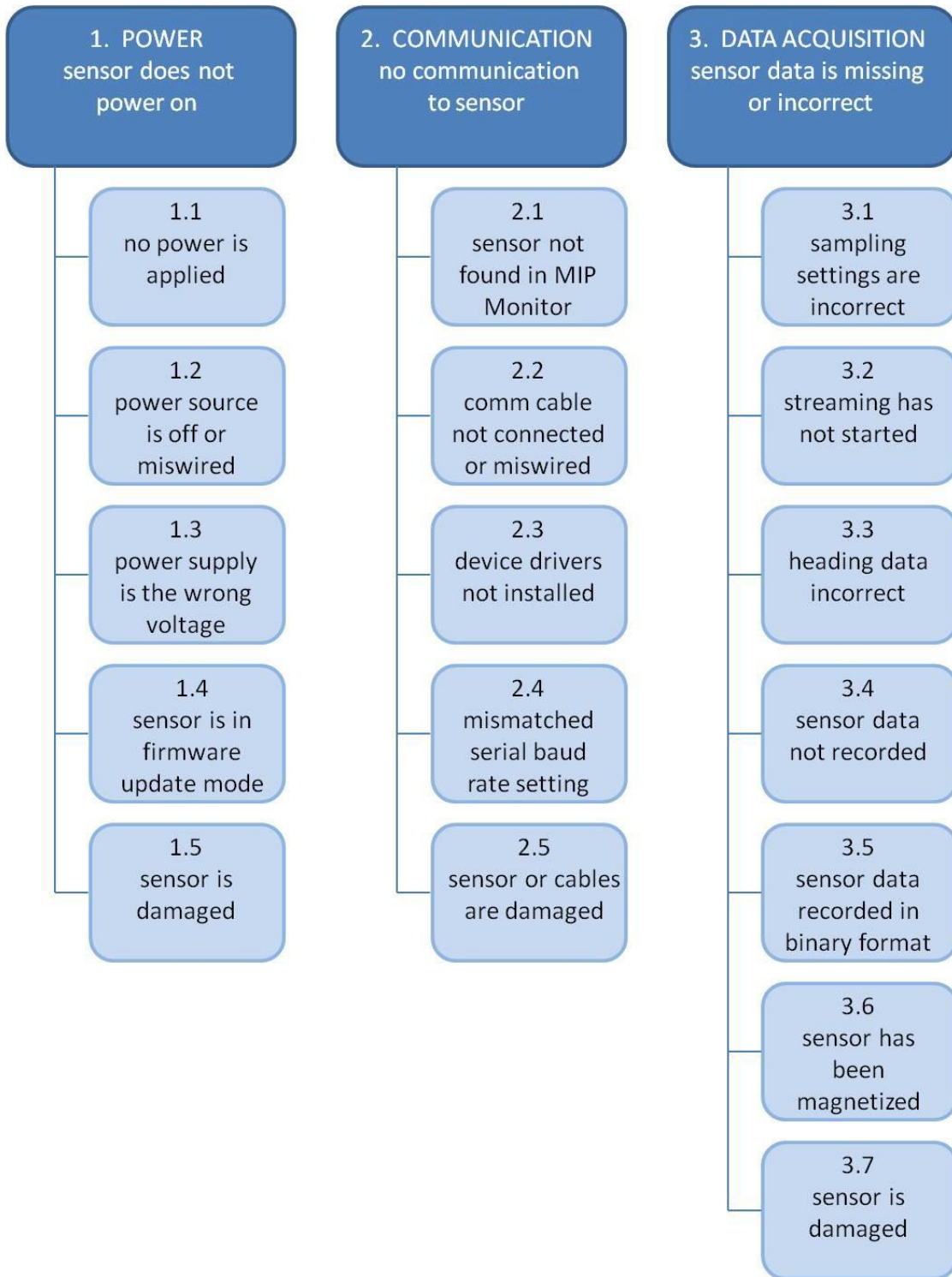

Problem	Possible cause and recommended solution
1. POWER sensor does not power on	1.1 no power is applied The status indicator on the device will be off. Make sure the sensor is connected to a power source and the status indicator illuminates.
	1.2 power source is off or miswired Verify the device power source is connected correctly.
	1.3 power supply is the wrong voltage Using a power supply other than the one provided with the device, or a supply that is outside of the device operating range, could result in permanent damage or cause it to not work properly.
	1.4 sensor is in firmware update mode Firmware update mode is used when updating firmware on the device. If the firmware updater fails, it is possible that the device can get stuck in the firmware update mode, and the sensor will be non-responsive. Contact LORD Sensing Technical Support (See Technical Support on page 58).
	1.5 sensor is damaged If all power settings and connections have been verified, and the sensor is still unresponsive, contact LORD Sensing Technical Support (See Technical Support on page 58).
2. COMMUNICATION no communication to sensor	2.1 sensor not found in MIP Monitor In MIP Monitor use the Refresh button to look for the sensor again. If the sensor is still not found try cycling power to the sensor and refreshing.
	2.2 communication cable not connected or miswired Check, remove, and reconnect communications and power cables as applicable. Replace or rewire as needed.
	2.3 device drivers not installed Verify the drivers (included with MIP Monitor Software Suite) are installed on the computer and that the software has had sufficient time to detect it. See Software Installation on page 11
	2.4 serial baud rate setting (not applicable to USB devices) The host computer serial port baud rate and the sensor baud settings must match in order for communication be established. In MIP Monitor this occurs automatically and the baud rate can only be changed once initial communication is established. To change the baud rate in MIP Monitor select Settings > System and select the desired rate. NOTE: if the baud rate is set higher than the computer serial port is capable of reading, communication will be permanently lost with the device. To recover, it will need to be connected to a higher speed port, connected via USB cable, or sent to LORD

Problem	Possible cause and recommended solution
	<p>Sensing for reconfiguration.</p> <p>2.5 sensor or cables are damaged Verify all connections, power, and settings. If available, try installing an alternate cable or sensor one at a time to see if the faulty device can be identified. If no conclusion can be determined, or to send a device in for repair, contact LORD Sensing Technical Support (<i>See Technical Support on page 58</i>).</p>
<p>3. DATA ACQUISITION sensor data is missing or incorrect</p>	<p>3.1 sampling settings are incorrect If unexpected measurements or sampling rates are displayed or recorded, enter the Device Settings menu and verify the sampling settings.</p>
	<p>3.2 streaming has not started If data streaming is occurring the sensor device status indicator will also be flashing to indicate sampling. In MIP Monitor the device status information field will indicate Streaming. If the sensor is not streaming data, activate it in the software.</p>
	<p>3.3 heading data incorrect If the magnetometers have not been field-calibrated, erroneous heading data could result.</p>
	<p>3.4 sensor data not recorded Verify data recording has been activated. In MIP Monitor the device status information field will indicate Recording Data. If the sensor isn't recording, activate in the software. Verify specific measurements have been enabled for sampling and recording. NOTE: Data is recorded in time sequence. If measurements are set to different sample rates, not all time intervals will include a reading from each output that is being recorded.</p>
	<p>3.5 sensor data recorded in binary format When data recording is started the user can choose between CSV and Binary output formats. If the data is recorded in Binary format it will require a translation program that utilizes the LORD Sensing MIP Data Communications Protocol (DCP) to make itreadable.</p>
	<p>3.6 sensor has been magnetized Contact or close proximity with magnets may disrupt the sensor operation and cause magnetization of internal components, which can affect magnetometer performance. If magnetization is suspected, use a degaussing tool to demagnetize.</p>
	<p>3.7 sensor is damaged With the sensor in a static neutral position data, look for baseline offset or drift on the IMU sensor outputs. Sensor damage can occur as a result of excessive g- force other</p>

Problem	Possible cause and recommended solution
	conditions outside of its operating specifications.

8.2 Repair and Calibration



General Instructions

In order to return any LORD Sensing product, you must contact LORD Sensing Sales or Technical Support to obtain a Return Merchandise Authorization (RMA) number. All returned merchandise must be in the original packaging, including manuals, accessories, cables, etc. with the RMA number clearly printed on the outside of the package. Removable batteries should be removed and packaged in separate protective wrapping. Please include the LORD Sensing model number and serial number, as well as your name, organization, shipping address, telephone number, and email. Normal turn-around for RMA items is seven days from receipt of item by LORD Sensing .



Warranty Repairs

LORD Sensing warrants its products to be free from defective material and workmanship for a period of one (1) year from the original date of purchase. LORD Sensing will repair or replace, at its discretion, a defective product if returned to LORD Sensing within the warranty period. This warranty does not extend to any LORD Sensing products that have been subject to misuse, alteration, neglect, accident, incorrect wiring, mis- programming, or use in violation of operating instructions furnished by LORD Sensing . It also does not extend to any units altered or repaired for warranty defect by anyone other than LORD Sensing .



Non-Warranty Repairs

All non- warranty repairs/replacements include a minimum charge. If the repair/replacement charge exceeds the minimum, LORD Sensing will contact the customer for approval to proceed beyond the minimum with the repair/replacement.

8.3 Maintenance

There are no user- serviceable parts on the 3DM - GX5 - 25. Removing the device cover or disassembling in any way voids the product warranty.

8.4 Technical Support

There are many resources for product support found on the LORD Sensing website including technical notes, FAQs, and product manuals.

http://www.microstrain.com/support_overview.aspx

For further assistance our technical support engineers are available to help with technical and applications questions.

Technical Support

sensing_support@LORD.com

Phone: 802-862-6629

SKYPE: microstrain.orientation.support

Live Chat is available from the website during business hours:
9:00 AM to 5:00 PM (Eastern Time US & Canada)

9. Parts and Configurations

9.1 Standard Configurations

For the most current product information, custom, and OEM options not listed below, refer to the LORD Sensing website or contact the LORD Sensing Sales Department.

Table 4 - Model Numbers describes the standard models available at the time this manual was published. Once a model is selected, the part number is further defined by desired configuration and interface options. The model determines the first four digits of the product part number; the options are indicated in the last four digits (*Figure 39 - Standard Part Numbers*).

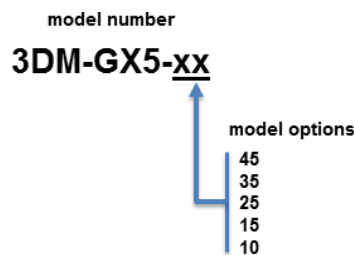

Model Number	Triaxial Accelerometers	Triaxial Gyroscope	Triaxial Magnetometer	Internal GNSS Receiver	Altitude Measurements	Auto-Adaptive Extended Kalman Filter	part number
3DM-GX5-10	X	X					6255-xxxx
3DM-GX5-15	X	X			X	X	6254-xxxx
3DM-GX5-25	X	X	X		X	X	6253-xxxx
3DM-GX5-35	X	X	X	X	X		6252-xxxx
3DM-GX5-45	X	X	X	X	X	X	6251-xxxx

Table 4 - Model Numbers

The same options are available in each model, and are indicated in the last four digits of the product part number. For a list of the starter kit contents, ([see Components on page 1](#)).

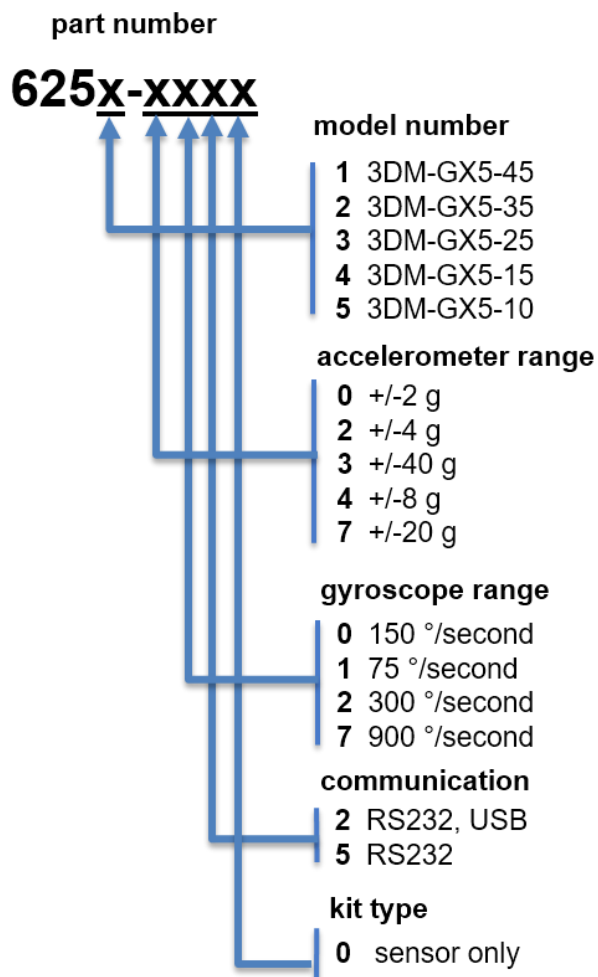

Figure 39 -Standard Part Numbers

9.2 Accessories

The following parts are available for use with the 3DM - GX5 - 25. For the most current product information refer to the LORD Sensing website or contact the Sales Department. (*see Sales Support on page 61*).

Description	LORD Sensing Part Number
RS232 connectivity kit	6212-3000
USB connectivity kit	6212-3002

Table 5 - Sensor Accessories

Description	Manufacturer part number
"A" Series or "P" Series 9-pin male Micro-D connector	Ulti-Mate PR09N05

Table 6 - Sensor Mating Connector

9.3 Sales Support

Products can be ordered directly from the LORD Sensing website by navigating to the product page and using the Buy feature.

<http://www.microstrain.com/inertial>

For further assistance, our sales team is available to help with product selection, ordering options, and questions.

Sales Support

sensing_sales@LORD.com

Phone: 802-862-6629

9:00 AM to 5:00 PM (Eastern Time US & Canada)

10. Specifications

General			
Integrated sensors	Triaxial accelerometer, triaxial gyroscope, triaxial magnetometer, pressure altimeter, and temperature sensors,		
Data outputs	Inertial Measurement Unit (IMU) outputs: acceleration, angular rate, magnetic field, ambient pressure, Delta-theta, Delta-velocity Computed outputs: Extended Kalman Filter (EKF): filter status, timestamp, attitude estimates (in Euler angles, quaternion, orientation matrix), linear and compensated acceleration, bias compensated angular rate, pressure altitude, gravity-free linear acceleration, gyroscope and accelerometer bias, scale factors and uncertainties, gravity and magnetic models, and more.		
Inertial Measurement Unit (IMU) Sensor Outputs			
	Accelerometer	Gyroscope	Magnetometer
Measurement range	±8 <i>g</i> (standard) ±2 <i>g</i> , ±4 <i>g</i> , ±20 <i>g</i> , ±40 <i>g</i> (optional)	300°/sec (standard) ±75, ±150, ±900 (optional)	±8 Gauss
Non-linearity	±0.02 fs	±0.02% fs	±0.3% fs
Resolution	<0.1 <i>mg</i>	<0.003°/sec	--
Bias instability	±0.04 <i>mg</i>	8°/hr	--
Initial bias error	±0.002 <i>g</i>	±0.04°/sec	±0.003 Gauss
Scale factor stability	0.03%	±0.05%	±0.1%
Noise density	25 µ <i>g</i> /√Hz (2 <i>g</i>)	0.005°/sec/√Hz (300°/sec)	400 µGauss/√Hz
Alignment error	±0.05°	±0.05°	±0.05°
Adjustable bandwidth	225 Hz (max)	250 Hz (max)	-
Offset error over temperature	0.06% (typ)	0.04% (typ)	--
Gain error over temperature	0.03% (typ)	0.03% (typ)	--
Scale factor non-linearity (@ 25° C)	0.02% (typ) 0.06% (max)	0.02% (typ) 0.06% (max)	±0.0015 Gauss
Vibration induced noise	--	0.072°/s RMS/ <i>g</i> RMS	--
Vibration rectification error (VRE)	--	0.001°/s/ <i>g</i> ² RMS	--
IMU filtering	Digital sigma-delta wide band anti-aliasing filter to digital averaging filter (user adjustable) scaled into physical units.		
Sampling rate	1 kHz	4 kHz	100 Hz
IMU data output rate	1 Hz to 1 kHz		
Pressure Altimeter			
Range	-1800 m to 10,000 m		
Resolution	< 0.1 m		
Noise density	0.01 hPa RMS		
Sampling rate	25 Hz		

Computed Outputs	
Attitude accuracy	EKF outputs: $\pm 0.25^\circ$ RMS roll and pitch, $\pm 0.8^\circ$ RMS heading (typ) CF outputs: $\pm 0.5^\circ$ RMS roll and pitch, $\pm 1.5^\circ$ RMS heading (typ)
Attitude heading range	360° about all axes
Attitude resolution	< 0.01°
Attitude repeatability	0.2° (typ)
Calculation update rate	500 Hz
Computed data output rate	EKF outputs: 1 Hz to 500 Hz CF outputs: 1 Hz to 1000 Hz
Operating Parameters	
Communication	USB 2.0 (full speed) RS232 (9,600 bps to 921,600 bps, default 115,200)
Power source	+4 to +36 V dc V dc
Power consumption	500 mW (typ)
Operating temperature	-40 °C to +85 °C
Mechanical shock limit	500g/1ms survivability
Physical Specifications	
Dimensions	36.0 mm x 36.6 mm x 11.1 mm
Weight	16.5 grams
Enclosure material	Aluminum
Regulatory compliance	ROHS, CE
Integration	
Connectors	Data/power output: micro-DB9
Software	MIP Monitor, Windows XP/Vista/7/8/10 compatible
Compatibility	Protocol compatibility across 3DM-GX3, GX4, RQ1, GQ4, GX5 and CV5 product families
Software development kit (SDK)	MIP data communications protocol with sample code available (OS and platform independent)

Subject to change without notice

11. Reference Diagrams

The diagrams in this section are to intended to aid in product installation and troubleshooting. For more information contact LORD Sensing Technical Support ([see *Technical Support on page 58*](#)).

11.1 Sensor Dimensions and Origin

This diagram describes the sensor physical specification including the measurement point of origin.

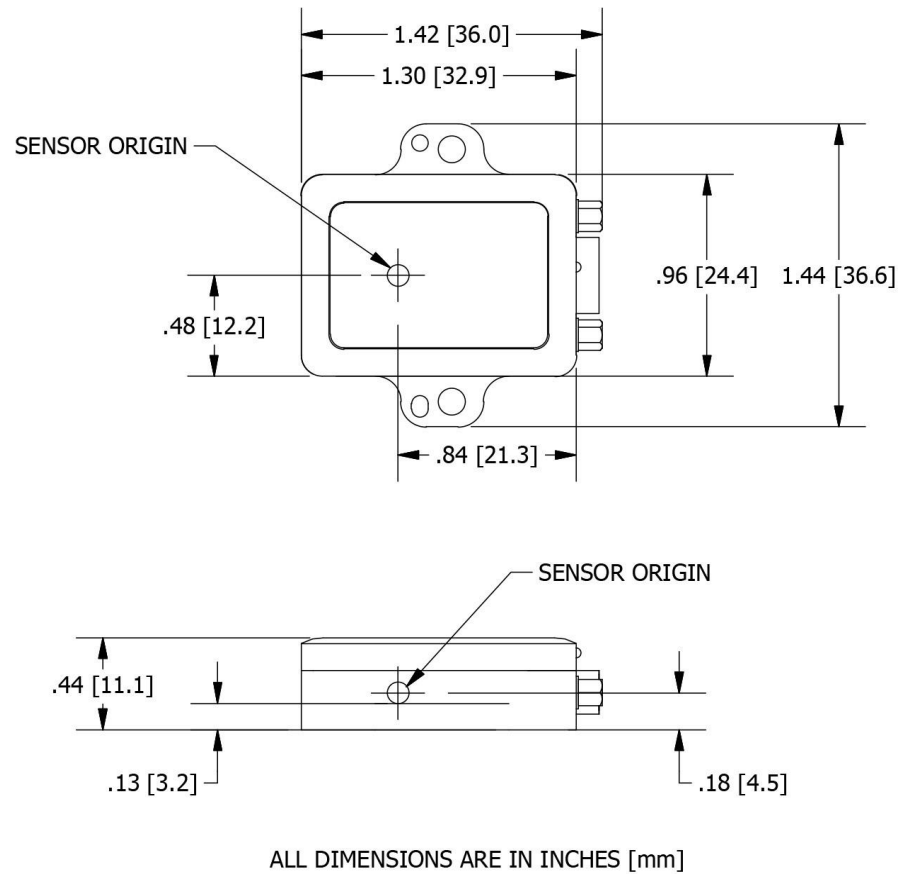
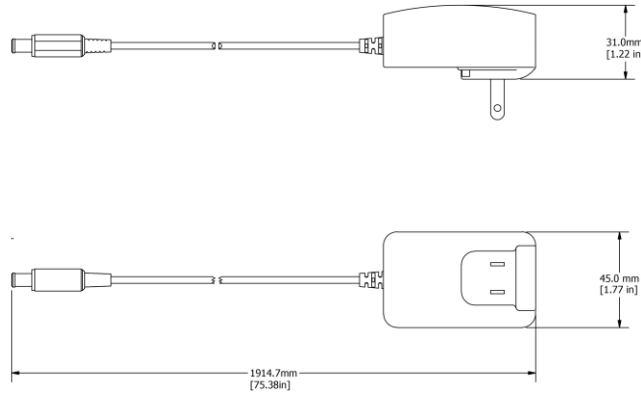

Figure 40 - 3DM-GX5-25 Sensor Origin

11.2 Power Supply Specifications

These specifications describe the power supply included in the 3DM-GX5-25 connectivity kit.



Operating Parameters	
AC input voltage rating	100 to 240 V ac
AC input voltage range	90 to 264 V ac
AC input frequency range	47 to 63 Hz
AC input current	(RMS) maximum @ 120 V ac (RMS) maximum @ 240 V ac
Leakage current	0.25 mA maximum @ 254 V ac
Inrush current (cold start @ 25 °C)	V ac @ maximum load V ac @ maximum load
Input power saving (at no load)	0.3 W maximum
DC voltage rating	
DC load capacity	maximum
Ripple	peak to peak maximum
Regulation	± 5 % line and load
Efficiency	% average
Circuit protection	auto restart
Safety approvals	cUL/UL, SAA, CE, C-Tick
Environmental Parameters	
Operating temperature	0 °C to +40 °C
Storage temperature	-25 °C to +
Humidity	to 90 %
Emissions	FCC Class B, EN55022 Class B
Dielectric withstanding (hi-pot) test	primary to secondary: 3000 V ac
Physical Specifications	
Dimensions	
Weight	
DC output connector	2.1 mm x 5.5 mm center positive standard
Mating connector	Kycon KLD-0202-A or equivalent

11.3 Communication and Power Cables

These diagrams describe the cables included in the 3DM- GX5- 25 connectivity kits. Only one is included in each kit, depending on the type of kit ordered.

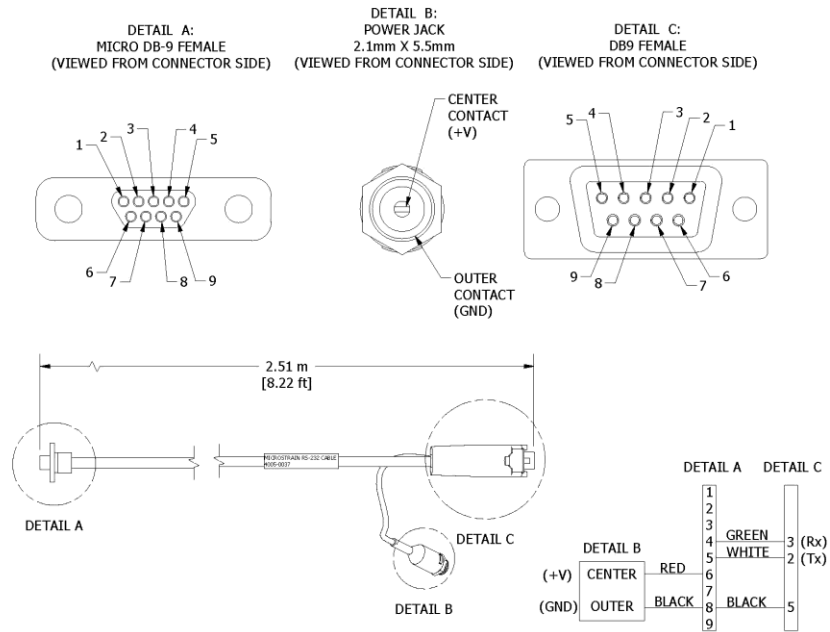

Figure 41 -RS232 Communications and power cable

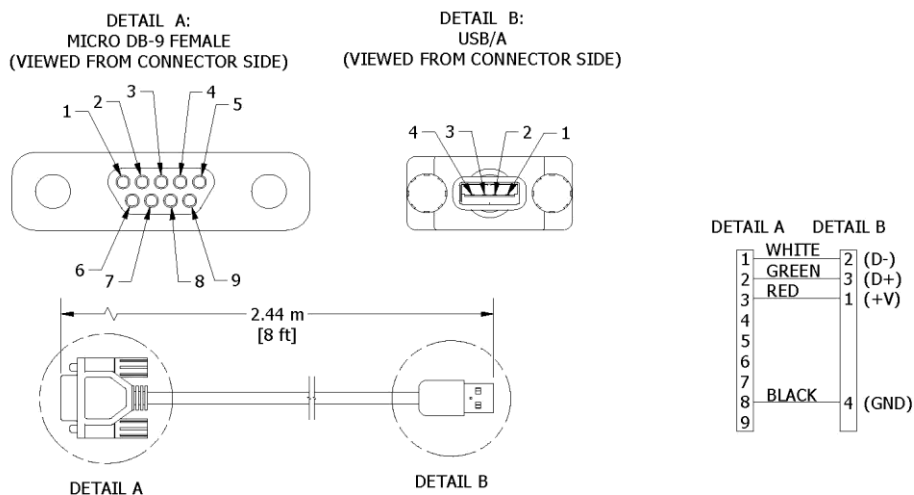

Figure 42 -USB Communications cable

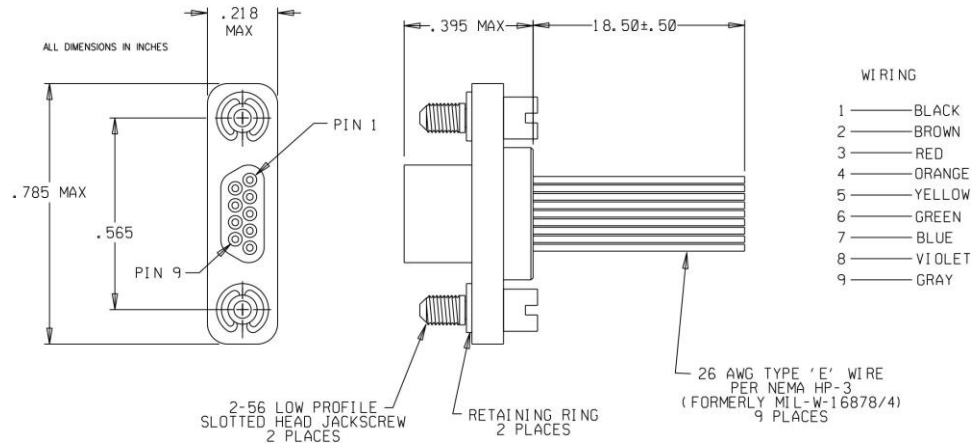

Figure 43 -Connector interface cable (sold separately, PN: 6224-0100)

12. Reference Documents

Many references are available on the LORD Sensing website including product user manuals, technical notes, and quick start guides. These documents are continuously updated and may provide more accurate information than printed or file copies.

Document	Where to find it
3DM-GX5-25 support documentation	http://www.microstrain.com/documents/inertial
NIST Calibration Procedures	http://www.nist.gov/calibrations/
ASTM Testing Procedures	http://www.astm.org/Standard/standards-and-publications.html

Table 7 - Document Resources

13. Glossary

A

A/D Value

The digital representation of analog voltages in an analog-to-digital (A/D) conversion. The accuracy of the conversion is dependent on the resolution of the system electronics. Higher resolution produces a more accurate conversion.

Acceleration

In physics, acceleration is the change in the rate of speed (velocity) of an object over time.

Accelerometer

A sensor used to detect and measure magnitude and direction of an acceleration force (g-force) in reference to its sensing frame. For example, at rest perpendicular to the Earth's surface an accelerometer will measure 9.8 meters/second squared as a result of gravity. If the device is tilted the acceleration force will change slightly, indicating tilt of the device. When the accelerometer is moving it will measure the dynamic force (including gravity).

Adaptive Kalman Filter (AKF)

A type of Extended Kalman Filter (EKF) that contains an optimization algorithm that adapts to dynamic conditions with a high dependency on adaptive technology. Adaptive technology refers to the ability of a filter to selectively trust a given measurement more or less based on a trust threshold when compared to another measurement that is used as a reference. Sensors that have estimation filters that rely on adaptive control elements to improve their estimations are referred to as an AKF.

AHRS (Attitude and Heading Reference System)

A navigation device consisting of sensors on the three primary axes used to measure vehicle direction and orientation in space. The sensor measurements are typically processed by an onboard algorithm, such as an Estimation Filter, to produce a standardized output of attitude and heading.

Algorithm

In math and science, an algorithm is a step-by-step process used for calculations.

Altitude

the distance an object is above the sea level

Angular rate

The rate of speed of which an object is rotating. Also known as angular frequency, angular speed, or radial frequency. It is typically measured in radians/second.

API (Applications Programming Interface)

A library and/or template for a computer program that specifies how components will work together to form a user application: for example, how hardware will be accessed and what data structures and variables will be used.

ASTM (Association of Standards and Testing)

a nationally accepted organization for the testing and calibration of technological devices

Attitude

the orientation of an object in space with reference to a defined frame, such as the North-East-Down (NED) frame

Azimuth

A horizontal arc measured between a fixed point (such as true north) and the vertical circle passing through the center of an object

B

Bias

A non-zero output signal of a sensor when no load is applied to it, typically due to sensor imperfections. It is also called offset.

C

Calibration

to standardize a measurement by determining the deviation standard and applying a correction, or calibration, factor

Complementary Filter (CF)

A term commonly used for an algorithm that combines the readings from multiple sensors to produce a solution. These filters typically contain simple filtering elements to smooth out the effects of sensor over-ranging or anomalies in the magnetic field.

Configuration

A general term applied to the sensor indicating how it is set up for data acquisition. It includes settings such as sampling rate, active measurements, measurement settings, offsets, biases, and calibration values

Convergence

when mathematical computations approach a limit or a solution that is stable and optimal.

D

Data Acquisition

the process of collecting data from sensors and other devices

Data Logging

the process of saving acquired data to the system memory, either locally on the device, or remotely on the host computer

Data rate

the rate at which sampled data is transmitted to the host

Delta-Theta

the time integral of angular rate expressed with reference to the device local coordinate system, in units of radians

Delta-velocity

the time integral of velocity expressed with reference to the device local coordinate system, in units of $g \cdot \text{second}$ where g is the standard gravitational constant

E

ECEF (Earth Centered Earth Fixed)

a reference frame that is fixed to the earth at the center of the earth and turning about earth's axis in the same way as the earth

Estimation Filter

A mathematical algorithm that produces a statistically optimum solution using measurements and references from multiple sources. Best known estimation filters are the Kalman Filter, Adaptive Kalman Filter, and Extended Kalman Filter.

Euler angles

Euler angles are three angles use to describe the orientation of an object in space such as the x, y and z or pitch; roll; and yaw. Euler angles can also represent a sequence of three elemental rotations around the axes of a coordinate system.

Extended Kalman Filter (EKF)

Used generically to describe any estimation filter based on the Kalman Filter model that can handle non-linear elements. Almost all inertial estimation filters are fundamentally EKFs.

G

GNSS (Global Navigation Satellite System)

a global network of space based satellites (GPS, GLONASS, BeiDou, Galileo, and others) used to triangulate position co-ordinates and provide time information for navigational purposes

GPS (Global Positioning System)

a U.S. based network of space based satellites used to triangulate position co-ordinates and provide time information for navigational purposes

Gyroscope

a device used to sense angular movements such as rotation

H

Heading

an object's direction of travel with reference to a co-ordinate frame, such as latitude and longitude

Host (computer)

The host computer is the computer that orchestrates command and control of attached devices or networks.

I

IMU

Inertial Measurement System

Inclinometer

device used to measure tilt, or tilt and roll

Inertial

pertaining to systems that have inertia or are used to measure changes in inertia as in angular or linear accelerations

INS (Inertial Navigation System)

systems that use inertial measurements exclusively to determine position, velocity, and attitude, given an initial reference

K

Kalman Filter

a linear quadratic estimation algorithm that processes sensor data or other input data over time, factoring in underlying noise profiles by linearizing the current mean and covariance to produce an estimate of a system's current state that is statistically more precise than what a single measurement could produce

L

LOS (Line of Sight)

Describes the ideal condition between transmitting and receiving devices in a wireless network. As stated, it means they are in view of each other with no obstructions.

M

Magnetometer

A type of sensor that measures the strength and direction of the local magnetic field with reference to the sensor frame. The magnetic field measured will be a combination of the earth's magnetic field and any magnetic field created by nearby objects.

MEMS (Micro-Electro-Mechanical System)

The technology of miniaturized devices typically made using micro fabrication techniques such as nanotechnology. The devices range in size from one micron to several millimeters and may include very complex electromechanical parts.

N

NED (North-East-Down)

A geographic reference system

O

OEM

acronym for Original Equipment Manufacturer

Offset

A non-zero output signal of a sensor when no load is applied to it, typically due to sensor imperfections. Also called bias.

Orientation

The orientation of an object in space with reference to a defined frame. Also called attitude.

P

Pitch

In navigation pitch is what occurs when vertical force is applied at a distance forward or aft from the center of gravity of the platform, causing it to move up or down with respect to the sensor or platform frame origin.

Position

The spatial location of an object

PVA

acronym for Position, Velocity, Attitude

Q

Quaternion

Mathematical notation for representing orientation and rotation of objects in three dimensions with respect to the fixed earth coordinate quaternion. Quaternions convert the axis-angle representation of the object into four numbers and to apply the corresponding rotation to a position vector representing a point relative to the origin.

R

Resolution

In digital systems, the resolution is the number of bits or values available to represent analog voltages or information. For example, a 12-bit system has 4096 bits of resolution and a 16-bit system has 65536 bits.

RMS

acronym for Root Mean Squared

Roll

In navigation roll is what occurs when a horizontal force is applied at a distance right or left from the center of gravity of the platform, causing it to move side to side with respect to the sensor or platform frame origin.

RPY

acronym for Roll, Pitch, Yaw

RS232

a serial data communications protocol

RS422

a serial data communications protocol

S

Sampling

the process of taking measurements from a sensor or device

Sampling rate

rate at which the sensors are sampled

Sampling Rate

the frequency of sampling

Sensor

a device that physically or chemically reacts to environmental forces and conditions and produces a predictable electrical signal as a result

Sigma

In statistics, sigma is the standard deviation from the mean of a data set.

Space Vehicle Information

refers to GPS satellites

Streaming

typically when a device is sending data at a specified data rate continuously without requiring a prompt from the host

U

USB (Universal Serial Bus)

A serial data communications protocol

UTC (Coordinated Universal Time)

The primary time standard for world clocks and time. It is similar to Greenwich Mean Time (GMT).

V

Vector

a measurement with direction and magnitude with reference from one point in space to another

Velocity

The rate of change of position with respect to time. Also called speed.

W

WAAS (Wide Area Augmentation System)

An air navigation aid developed to allow aircraft to rely on GPS for all phases of flight, including precision approaches to any airport.

WGS (World Geodetic System)

a protocol for geo-referencing such as WGS-84

Y

Yaw

In navigation yaw is what occurs when rotational force is applied at a distance forward or aft from the center of gravity of the platform, causing it to move around the center axis of a sensor or platform frame origin.